

# LIGHTING CONTROLS & WIRING DEVICES

2023/2024



# Enerlites®

Control  
Charge  
Connect

[enerlites.com](http://enerlites.com)



## ABOUT ENERLITES

Enerlites is a leading manufacturer of innovative sensors, USB charging receptacles, lighting controls, and wiring devices with over twenty years of experience in design and manufacturing. Our product line includes more than 50 patented devices with cutting-edge technology to ensure high energy efficiency and quality. Enerlites production facilities are among the most modern and technically advanced, with automated assembly lines to reduce the chance of human error. The facilities include an onsite lab certified for testing to UL standards. Our commitment to quality and safety is second to none. Every unit is inspected thoroughly throughout the manufacturing process and all applicable products are CA Title 20 and 24 certified, UL or ETL listed, and meet relevant NEC codes.

### ASSOCIATIONS

We are an active member of NEMA, helping to develop and maintain high standards in electrical manufacturing and promote the safe use of certified lighting control and wiring devices. As a proud member of NEMRA and NAED, we provide our team with powerful industry-specific tools and stay on top of market trends to appropriately react to changing customer needs.

### SUPPORT

The Enerlites team dedicates itself to supporting every facet of the customer experience. We ensure that each inquiry is handled with professionalism and care. Our hands-on customer service team promptly and thoroughly handles all inquiries. We pride ourselves on low return rates and quick turnaround times. We make it a priority to listen to the needs of our customers to ensure complete satisfaction.

### APPROACH

Customer needs and evolving technology standards are the driving forces of innovation and production at Enerlites. We design with our customers in mind, whether they be homeowners looking for the latest smart devices or businesses aiming to enhance the customer experience through the latest high-speed USB charging systems. Our products answer to both functionality and aesthetic appeal.

### PRODUCTS

Enerlites leads the market in USB charging devices. To date, we've set the market standards for the safest and fastest in-wall USB receptacles. With the integration of Gallium Nitride technology and Power Delivery through USB-C, we are equipped to handle the most modern devices at top speeds. Beyond speed and reliability, Enerlites' USB charging devices cater to heavy use in residential and commercial applications. Interchangeable modules allow for quick changes with minimal effort and cost, while interchangeable face covers come in various colors and give worn outlets an immediate facelift.

Dual technology sensors combine Passive Infrared Technology with Ultrasonic Sensors in our switches to enhance accuracy and detect fine motion. We offer various combinations with different levels of customization settings for broad appeal in residential and commercial applications. This hands-free option promotes energy efficiency and convenience.



# Table of Contents



**A | USB CHARGER RECEPTACLES**

Interchangeable USB Modules	A3
Type-A/C USB's	A4 - A5
Power Delivery USB's	A6



**B | SENSING CONTROLS**

Wall Switch Sensors	B3 - B6
Line Voltage Sensors	B7 - B9
Low Voltage Sensors	B10 - B11
Room Controls	B12
Power Pack and Adapters	B13
Humidity Sensors	B14
Air Circulators & Fan Controls	B15



**C | PLUG LOAD CONTROLS**

Wireless Plug Load Controls	C2
-----------------------------	----



**D | TIMER SWITCHES**

Programmable Digital Timer Switches	D2
Preset Timer Switches	D3 - D4



**E | DIMMERS & FAN SPEED CONTROLS**

LED Dimmer Switches	E2 - E3
Fan Speed Controls	E4



**F | STRAIGHT BLADE DEVICES**

Residential Grade	F3, F7
Commercial Grade	F4
Industrial Grade	F5, F8
Decorator Devices	F7
30 & 50 Amp Power Devices	F9
Surge Suppressors	F10



**G | SWITCHES**

Toggle Switches	G2 - G3
Decorator Switches	G4 - G5



**H | COMBINATION DEVICES**

Combination Devices	H2
Guide Light Devices	H3



**I | LOCKING DEVICES**

NEMA 15 & 20 Amp Locking Devices	I3
NEMA 30 Amp Locking Devices	I4
Straight Blade Devices	I5



**J | FLOOR BOXES AND COVERS**

Flush Floor Boxes	J2
Pop-Up Floor Boxes	J3 - J4
Floor Box Covers	J4
Floor Box Flanges	J5
Junction Boxes & Accessories	J5



**K | DATA-COM DEVICES & WALL PLATES**

Audio/Video Connectors	K2
Decorator Adapters	K3
Multimedia Wall Plates	K4
Recessed Cable Plates	K5
Molded-In Voice and Audio/Video	K6
Telephone Wall Jacks	K7
Telephone and CATV Jacks	K8



**L | WALL PLATES & COVERS**

Screwless Wall Plates	L3 - L6
Plastic Wall Plates	L7 - L13
Stainless Steel Wall Plates	L14 - L18
Weatherproof Covers & Boxes	L19 - L20



**M | HOME AUTOMATION**

Z-Wave Smart Devices	M3
Wi-Fi Smart Devices	M4



**N | ANTIMICROBIAL PRODUCTS**

Antimicrobial Switches	N2
Antimicrobial Wall Plates	N3

# A

# USB Charger Receptacles



E  
A1



Interchangeable USB Modules	A3
Type-A/C USB's	A4 - A5
Power Delivery USB's	A6

**ENERLITES** offers a wide variety of in-wall USB charging receptacles with multiple configurations. Options include devices that combine USB ports with 15A or 20A power outlets, interchangeable modules, and devices featuring fast-charging technology. In-wall USB chargers use advanced smart chips that detect a device's power needs to maximize charging speed and efficiency. Our Power Delivery charging technologies supply higher power levels for supported devices.

With an in-wall USB receptacle, you can enjoy the convenience of adapter-free USB charging. AC adapters are no longer required, simply plug your cable into the USB port and start charging. They are designed to replace any traditional wall outlet for a modern and organized charging station.





# Charge devices faster than ever with Power Delivery

This technology allows users to charge most smartphones, tablets, and even select laptops at optimized speeds and efficiency.

## The new standard for fast charge technology

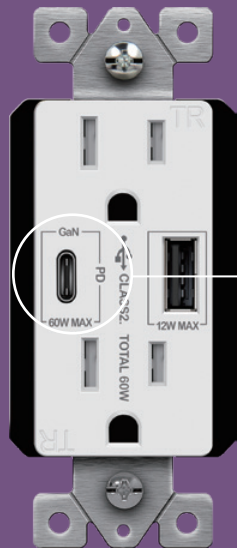

Up to 60W with a USB-C Cable

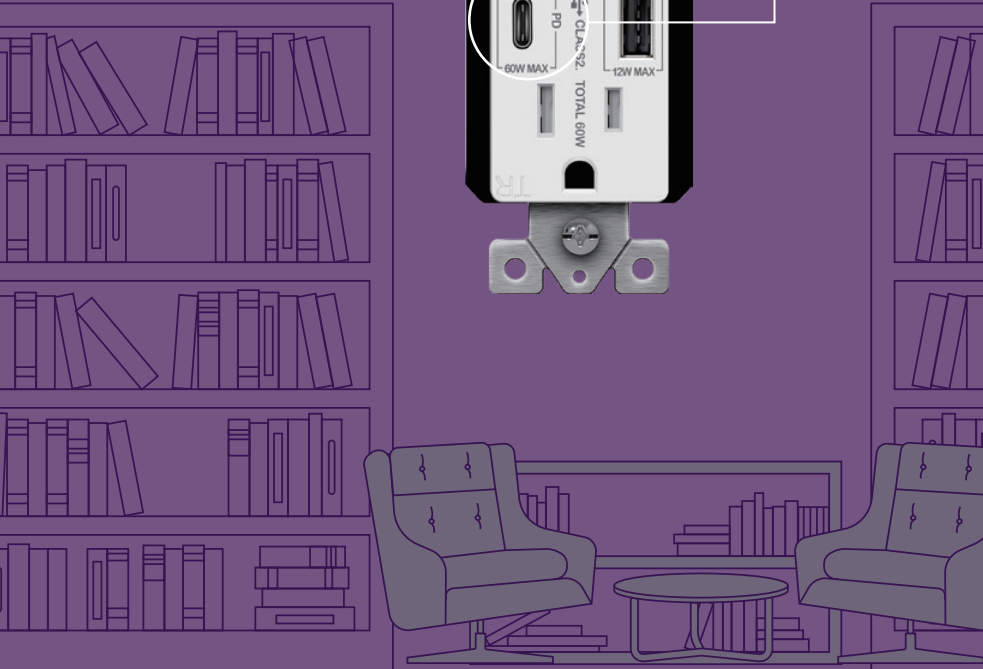

## Interchangeable USB Module Charger Receptacles

### Features:

- 2 high-speed USB charging ports with 4.8A total output
- 3 high-speed USB charging ports with 5.8A total output
- Interchangeable USB module for quick service calls
- Residential/Commercial grade specifications
- Built-in smart chip recognizes each device's individual charging requirements to optimize the charge
- Tested to withstand over 10,000 insertions
- Tamper-resistant receptacle improves child safety – built-in shutter prevents access by most non-rated/foreign objects
- Fits in a standard wall box, compatible with standard wall plates
- Back wiring
- 2-year warranty

### Testing & Code Compliance:



### Type A/C USB Charger Single Receptacles



61150-A2C5-CU-W

DESCRIPTION	RATING	CAT. NO.	COLOR
Interchangeable Dual Type-A USB Charger with 15A Tamper-Resistant Receptacle	15A, 125 VAC, USB 4.8A, 5 VDC	61150-TR2USB-CU	White
Interchangeable Dual Type-A USB Charger with 20A Tamper-Resistant Receptacle	20A, 125 VAC, USB 4.8A, 5 VDC	61200-TR2USB-CU	White
Interchangeable Three Type-A USB Charger with 15A Tamper-Resistant Receptacle	15A, 125 VAC, USB 5.8A, 5 VDC	61150-TR3USB-CU	White
Interchangeable Three Type-A USB Charger with 20A Tamper-Resistant Receptacle	20A, 125 VAC, USB 5.8A, 5 VDC	61200-TR3USB-CU	White
Interchangeable Type A and Dual Type-C USB Charger with 15A Tamper-Resistant Receptacle	15A, 125 VAC, USB 5.8A, 5 VDC	61150-A2C5-CU	White
Interchangeable Type A and Dual Type-C USB Charger with 20A Tamper-Resistant Receptacle	20A, 125 VAC, USB 5.8A, 5 VDC	61200-A2C5-CU	White Gray



USB15L3-W

### Interchangeable USB Modules

DESCRIPTION	RATING	CAT. NO.	COLOR
Three Type-A USB 15A Module	15A-125V	USB15L3	White
Three Type-A USB 20A Module	20A-125V	USB20L3	White
Type-A and Dual Type-C USB 15A Module	15A-125V	USB15L3A2C	White
Type-A and Dual Type-C USB 20A Module	20A-125V	USB20L3A2C	White Gray
Type-C and Dual Type-A USB 15A Module	15A-125V	USB15L3AC	White
Type-C and Dual Type-A USB 20A Module	20A-125V	USB20L3AC	White Gray



## Type-A USB Charger Receptacles

### Features:

- 2 high-speed USB Charging ports with 4.0-4.8A total output
- 3 high-speed USB Charging ports with 5.8A total output
- 4 high-speed USB charging ports with 5.8A total output
- Interchangeable face covers
- Residential/Commercial grade specifications
- Built-in smart chip recognizes each device's individual charging requirements to optimize the charge
- Tested to withstand over 10,000 insertions
- Tamper-resistant receptacle improves child safety – built-in shutter prevents access by most non-rated/foreign objects
- Fits in a standard wall box, compatible with standard wall plates
- Back wiring
- 2-year warranty

### Testing & Code Compliance:



### Interchangeable Type-A USB Charger Receptacles



61501-TR2USB-CC-W

DESCRIPTION	RATING	CAT. NO.	COLOR
Dual Type-A USB Charger with 15A Duplex Tamper-Resistant Receptacles and Interchangeable Face Covers	15A, 125 VAC, USB 4.8A, 5 VDC	61501-TR2USB-CC	White* Gray
Dual Type-A USB Charger with 20A Duplex Tamper-Resistant Receptacles and Interchangeable Face Covers	20A, 125 VAC, USB 4.8A, 5 VDC	62001-TR2USB-CC	White* Gray
Three Type-A USB Charger with 15A Duplex Tamper-Resistant Receptacles and Interchangeable Face Covers	15A, 125 VAC, USB 5.8A, 5 VDC	61501-TR3USB-CC	White* Gray
Three Type-A USB Charger with 20A Duplex Tamper-Resistant Receptacles and Interchangeable Face Covers	20A, 125 VAC, USB 5.8A, 5 VDC	62001-TR3USB-CC	White* Gray



62000-4USB58-W

### Type-A USB Charger Receptacles

DESCRIPTION	RATING	CAT. NO.	COLOR
Dual Type-A USB Charger with 15A Duplex Tamper-Resistant Receptacles	15A, 125 VAC, USB 4A, 5 VDC	61501-TR2USB-S	White

### 4-Port USB Charger

DESCRIPTION	RATING	CAT. NO.	COLOR
4-Port USB Charger	15A, 125VAC USB 5.8A, 5 VDC	62000-4USB58	White

\* Includes two interchangeable face covers: light almond and black



## Type-A/C USB Charger Receptacles

### Features:

- 2 high-speed individual USB charging port with 3.6A, 5A, or 5.8A total output
- Type-C port permits the cables to be inserted easily in either direction
- USB Type-C provides faster charging and is emerging as the standard port on many phones, tablets, and laptops
- Interchangeable face covers
- Residential/Commercial grade specifications
- Built-in smart chip recognizes each device's individual charging requirements to optimize the charge
- Tested to withstand over 10,000 insertions
- Tamper-resistant receptacle improves child safety – built-in shutter prevents access by most non-rated/foreign objects
- Fits in a standard wall box, compatible with standard wall plates
- Back wiring
- 2-year warranty

### Testing & Code Compliance:



### Type-A/C USB Charger Receptacles

DESCRIPTION	RATING	CAT. NO.	COLOR
Type-A/C USB Charger with 15A Duplex Tamper-Resistant Receptacles, 125 VAC; Combined Total of 3.6A Charging Power	15A, 125 VAC, USB Type-A Port: 5V/2.4A USB Type-C Port: 5V/3A	61501-TR2USB3-1A1C	White Light Almond Black
Type-A/C USB Charger with 20A Duplex Tamper-Resistant Receptacles, 125 VAC; Combined Total of 3.6A Charging Power	20A, 125 VAC, USB Type-A Port: 5V/2.4A USB Type-C Port: 5V/3A	62001-TR2USB3-1A1C	White
Type-A/C USB Charger with 15A Duplex Tamper-Resistant Receptacles, 125 VAC; Combined Total of 5A Charging Power	15A, 125 VAC, USB Type-A Port: 5V/2.4A USB Type-C Port: 5V/3A	61501-1A1C5	White
Type-A/C USB Charger with 20A Duplex Tamper-Resistant Receptacles, 125 VAC; Combined Total of 5A Charging Power	20A, 125 VAC, USB Type-A Port: 5V/2.4A USB Type-C Port: 5V/3A	62001-1A1C5	White
Type-A/C USB Charger with 15A Duplex Tamper-Resistant Receptacles, 125 VAC; Combined Total of 5.8A Charging Power	15A, 125 VAC, USB Type-A Port: 5V/2.4A USB Type-C Port: 5V/3A	61501-TR2USB-1A1C	White* Gray
Type-A/C USB Charger with 20A Duplex Tamper-Resistant Receptacles, 125 VAC; Combined Total of 5.8A Charging Power	20A, 125 VAC, USB Type-A Port: 5V/2.4A USB Type-C Port: 5V/3A	62001-TR2USB-1A1C	White* Gray
Dual Type-C USB Charger with 15A Duplex Tamper-Resistant Receptacles, 125 VAC; Combined Total of 3.6A Charging Power; Each Type-C Port Max- 3Amps@5V	15A, 125 VAC, USB Type-C Port: 5V/3A each port	61501-2C3	White
Dual Type-C USB Charger with 15A Duplex Tamper-Resistant Receptacles, 125 VAC; Combined Total of 5A Charging Power; Each Type-C Port Max- 3Amps@5V	15A, 125 VAC, USB Type-C Port: 5V/3A each port	61501-2C5	White

\* includes two interchangeable face covers: light almond and black



61501-TR2USB-1A1C-W



61501-2C3-W





## Power Delivery Type A/C USB Charger Receptacles

### Features:

- Powerful PD-enabled device connected to USB Type-C
- Type-C non-PD device 5VDC@3A
- Type-C Port permits cables to be inserted easily in either direction
- USB Type-C provides faster charging and is emerging as the standard port on many phones, tablets, and laptops
- Charging time may be affected by the charging cord used. Enerlites recommends using the cord provided with the device
- Interchangeable face covers
- Residential/Commercial grade specifications
- Built-in smart chip recognizes each device's individual charging requirements to optimize the charge
- Tested to withstand over 10,000 insertions
- Tamper-Resistant receptacles improve child safety – built-in shutter prevents access by most non-rated/foreign objects
- Fits in a standard wall box, compatible with standard wall plates
- Back wiring
- 2-year warranty

### Testing & Code Compliance:



### Power Delivery Type A/C 60W USB Charger Receptacle



61501-1A1C-PD60-W

DESCRIPTION	RATING	CAT. NO.	COLOR
60W Power Delivery USB Type A/C Tamper-Resistant Receptacles 15A 125VAC Combined Total of 60W Charging Power	15A-125V, USB Type-A Port: 5V/2.4A USB Type-C Port: 5V-2.4A/9V-3A/15V-3A/ 20V-3A	61501-1A1C-PD60	White



61501-1A1C-PD30-W

### Power Delivery Type A/C 30W USB Charger Receptacle

DESCRIPTION	RATING	CAT. NO.	COLOR
30W Power Delivery USB Type A/C Tamper-Resistant Receptacles 15A 125VAC	15A-125V USB Type-A Port: 5V/2.4A USB Type-C Port: 5V-2.4A/9V-3A/15V-2A	61501-1A1C-PD30	White



# Sensing Controls



E  
B1

Wall Switch Sensors	<b>B3 - B6</b>
Line Voltage Sensors	<b>B7 - B9</b>
Low Voltage Sensors	<b>B10 - B11</b>
Room Controls	<b>B12</b>
Power Pack & Adapters	<b>B13</b>
Humidity Sensors	<b>B14</b>
Air Circulators & Fan Controls	<b>B15</b>

From residential spaces to industrial locations and workplaces, lighting management is critical. Enerlites offers a wide variety of in-wall and ceiling-mounted sensor controls for lights and fans. Compatible with all standard lighting control systems, our sensors are easy to install and undergo meticulous testing for quality and performance.

This category includes both Passive Infrared (PIR) and PIR/Ultrasonic motion sensor switches, as well as humidity sensors, fresh air circulators, and dual-technology devices that utilize more than one of these features. There is also a variety of ceiling-mounted and high-bay occupancy sensors, with innovative adapters available to make their installation easier and faster.

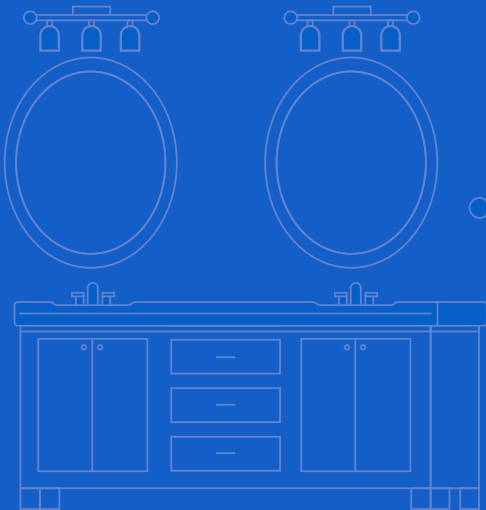

## Occupancy and vacancy sensors

Lighting controls are traditionally used to control the intensity of lighting within a space and allow the atmosphere of the room to be adjusted to the user's specifications. Over the last decade, occupancy sensors have been designed into systems that control a wide variety of areas in residential, commercial, and industrial buildings. These applications consist of individually enclosed offices, large open workspaces, conference rooms, hallways, storage closets and more. Overall, occupancy sensors together with built-in photocell technology have been proven to reduce lighting-related energy consumption up to 45 percent depending on the application.

Currently, modern building designs are integrating electric light sources with natural light that penetrates the room through strategically placed windows. This enables the building owner to incorporate motion and photo controls to automatically adjust the electric lighting to a lower level and takes advantage of the natural light entering a space. The overall goal is to provide a comfortable and well-illuminated space for the user while reducing energy consumption.

Although occupancy sensors are most commonly used in commercial buildings, they are now being applied to residential homes in the form of a vacancy sensor. This type of sensor provides the manual ON function, but automatically turns the connected lighting OFF when the room becomes vacant. Residential applications that benefit from this type of control are generally bedrooms, bathrooms, laundry rooms, closets, and garages where lighting is often left on after occupancy.

With multi-level wiring, installing occupancy/vacancy sensors in residential, commercial, and industrial buildings can reduce energy consumption significantly. Enerlites sensors are of the highest quality for energy management and conservation.



Hands-free control



30-40% Energy savings

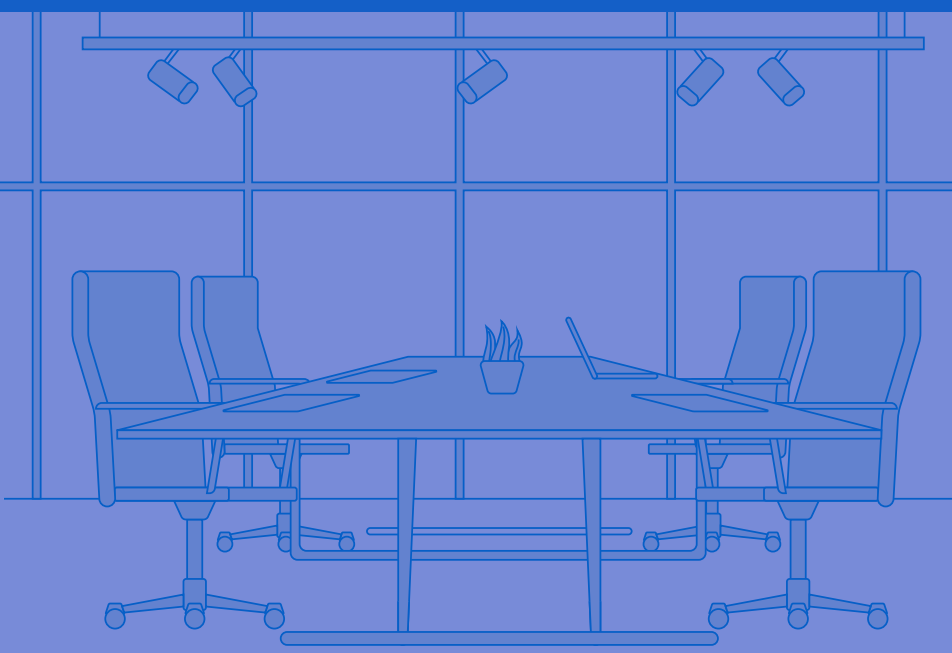



## In-Wall Occupancy/Vacancy Sensors

### Features:

- High sensitivity and dense coverage for exceptional performance
- Convenient push-button provides manual ON/OFF at any time
- Controls incandescent, CFL, and LED lighting
- LED indicator light flashes when sensor detects motion to verify detection is active
- Adjustable time delay 15 seconds to 20 minutes
- Single pole
- Vacancy Sensors can be used to comply with 2019 California Title 24, Part 6
- Interchangeable face covers
- 2-year warranty

### Testing & Code Compliance:



## Residential Grade In-Wall Passive Infrared Occupancy/Vacancy Sensors



HMOS-W

DESCRIPTION	RATING	CAT. NO.	COLOR
Single Pole OCC/VAC (2-in-1) Sensor Switch Neutral Wire Required	Voltage: 120 VAC, 60 Hz Resistive: 5A Incandescent: 500W @ 120 VAC Electronic Ballast: 500 VA @ 120 VAC Motor: 1/8 HP @ 120 VAC Coverage: 180°, 700 sq. ft.	HMOS	White Light Almond Ivory Black
Single Pole OCC/VAC (2-in-1) Sensor Switch Ground Wire Required	Voltage: 120/277 VAC, 60 Hz Resistive: 5A Incandescent: 500W @ 120 VAC Electronic Ballast: 500 VA @ 120 VAC; 1000 VA @ 277 VAC Motor: 1/8 HP @ 120 VAC Coverage: 180°, 700 sq. ft.	HMOS-J	White Light Almond Ivory Black

## Residential Grade In-Wall Passive Infrared Vacancy Sensors



HMVS-W

DESCRIPTION	RATING	CAT. NO.	COLOR
Single Pole Vacancy Sensor Switch Neutral Wire Required	Voltage: 120 VAC, 60 Hz Resistive: 5A Incandescent: 500W @ 120 VAC Electronic Ballast: 500 VA @ 120 VAC Motor: 1/8 HP @ 120 VAC Coverage: 180°, 700 sq. ft.	HMVS	White Light Almond Ivory Black
Single Pole Vacancy Sensor Switch Ground Wire Required	Voltage: 120/277 VAC, 60 Hz Resistive: 5A Incandescent: 500W @ 120 VAC Electronic Ballast: 500 VA @ 120 VAC; 1000 VA @ 277 VAC Motor: 1/8 HP @ 120 VAC Coverage: 180°, 700 sq. ft.	HMVS-J	White Light Almond Ivory Black

## In-Wall Occupancy/Vacancy Sensors

### Features:

- OCC/VAC modes available
- Convenient push-button provides manual ON/OFF at any time
- Adjustable time delay 15 seconds to 30 minutes
- Single pole or 3-way
- Neutral or Ground wire required on select models
- Zero crossing function applies to models DWOS-J and DWOS-JD
- "Walk-through" sensing mode increases energy savings by turning lights "OFF" shortly after momentary occupancy
- Controls incandescent, CFL, and LED lighting
- LED indicator light flashes when sensor detects motion to verify detection is active
- 5-year warranty

### Testing & Code Compliance:



## Commercial Grade In-Wall Passive Infrared Occupancy Sensors



DWOS-J-W



DWOS-JD-W

DESCRIPTION	RATING	CAT. NO.	COLOR
Single Pole OCC/VAC (2-in-1) Decorator Wall Switch Ground Wire Required	Voltage: 120/277 VAC, 60 Hz Resistive: 6.6A Tungsten: 800W @ 120 VAC Electronic Ballast: 800 VA @ 120 VAC; 1600 VA @ 277 VAC  Motor: 1/4 HP @ 120 VAC Coverage: 180°, 1200 sq. ft.	DWOS-J	White
Single Pole/3-Way OCC/VAC (2-in-1) Decorator Wall Switch Ground Wire Required	Voltage: 120/277 VAC, 60 Hz Resistive: 6.6A Tungsten: 800W @ 120 VAC Electronic Ballast: 800 VA @ 120 VAC; 1600 VA @ 277 VAC  Motor: 1/4 HP @ 120 VAC Coverage: 180°, 1200 sq. ft.	DWOS-3J	White
Single Pole OCC/VAC (2-in-1) Decorator Wall Switch Dual Relay Ground Wire Required	Voltage: 120/277 VAC, 60 Hz Resistive: 6.6A Tungsten: 800W @ 120 VAC Electronic Ballast: 800 VA @ 120 VAC; 1600 VA @ 277 VAC  Motor: 1/4 HP @ 120 VAC Coverage: 180°, 1200 sq. ft.	DWOS-JD	White
Single Pole OCC/VAC (2-in-1) Decorator Wall Switch Neutral Wire Required	Voltage: 120/277 VAC, 60 Hz Resistive: 10A Tungsten: 800W @ 120 VAC Electronic Ballast: 800 VA @ 120 VAC; 1600 VA @ 277 VAC  Motor: 1/4 HP @ 120 VAC Coverage: 180°, 1200 sq. ft.	DWOS-1277	White
Single Pole OCC/VAC (2-in-1) Decorator Wall Switch Night Light Neutral Wire Required	Voltage: 120/277 VAC, 60 Hz Resistive: 6.6A Tungsten: 800W @ 120 VAC Electronic Ballast: 800 VA @ 120 VAC; 1600 VA @ 277 VAC  Motor: 1/4 HP @ 120 VAC Coverage: 180°, 1200 sq. ft.	DWOS-1277-NL	White
Single Pole/3-Way OCC/VAC (2-in-1) Decorator Wall Switch Neutral Wire Required	Voltage: 120 VAC, 60 Hz Resistive: 12A Tungsten: 800W @ 120 VAC Electronic Ballast: 800 VA @ 120 VAC Motor: 1/4 HP @ 120 VAC Coverage: 180°, 1200 sq. ft.	DWOS-3R	White



## In-Wall Occupancy/Vacancy Sensors

### Features:

- OCC/VAC modes available
- Convenient push-button provides manual ON/OFF at any time
- Adjustable time delay 15 seconds to 30 minutes
- Single pole
- Zero crossing function
- "Walk-through" sensing mode increases energy savings by turning lights "OFF" shortly after momentary occupancy
- Controls incandescent, CFL, and LED lighting
- LED indicator light flashes when sensor detects motion to verify detection is active
- 5-year warranty

### Testing & Code Compliance:



## Commercial Grade In-Wall Dual-Tech Occupancy/Vacancy Sensor



MWOS-W

DESCRIPTION	RATING	CAT. NO.	COLOR
Single Pole OCC/VAC (2-in-1) Decorator Wall Switch PIR/Ultrasonic Dual Technology Neutral Wire Required	Voltage: 120/277 VAC, 50/60 Hz Resistive: 6.6A Tungsten: 800W @ 120 VAC Electronic Ballast: 600 VA @ 120 VAC; 1385 VA @ 277 VAC Motor: 1/4 HP @ 120 VAC Coverage: 180°, PIR Coverage: 1200 sq. ft. Ultrasonic: 400 sq. ft.	MWOS	White

## In-Wall Occupancy/Vacancy Sensors with Dimmer Switches

### Features:

- OCC/VAC modes available
- Combines Passive Infrared Technology and dimming
- Convenient push-button provides manual ON/OFF at any time
- Adjustable time delay, light level, and PIR sensitivity
- Time delay 15 seconds to 30 minutes
- Single pole
- Interchangeable face covers
- Works with dimmable LED bulbs, and 0-10V dimming
- LED indicator light flashes when the sensor detects motion to verify detection is active
- 5-year warranty

### Testing & Code Compliance:



### Occupancy/Vacancy Sensor with 0-10V Dimmer Switch



DWODS-010-W

DESCRIPTION	RATING	CAT. NO.	COLOR
Single Pole Occupancy/Vacancy Sensor with 0-10V Dimmer Switch Neutral Wire Required	Voltage: 120/277 VAC, 60 Hz Resistive: 6A @ 120 VAC; 3A @ 277 VAC Electronic Ballast/ LED: 800 VA Load Rating: 2mA - 30mA Motor: 1/8 HP Coverage: 180°, 1200 sq. ft.	DWODS-010	White



DWODS-120-W

### Occupancy/Vacancy Sensor with Line Voltage Dimmer Switch

DESCRIPTION	RATING	CAT. NO.	COLOR
Single Pole Occupancy/Vacancy Sensor Dimmer Switch 2 Wires Sensor	Voltage: 120VAC, 60Hz Tungsten: 600W Resistive: 3A Electronic Ballast/LED: 1.25 A/150 W Coverage: 180°, 1200 sq. ft.	DWODS-120	White



## Line Voltage Sensors

### Features:

- Passive Infrared Technology (PIR)
- 360° Fresnel lens for superior occupancy detection
- Adjustable time delay and light level
- Vacancy override by using momentary switch (optional)
- Works with fluorescent, LED, and 0-10V dimming
- LED indicator light flashes when sensor detects motion to verify detection is active
- 2-year warranty

### Testing & Code Compliance:



360° Line Voltage Ceiling Sensor			
DESCRIPTION	RATING	CAT. NO.	COLOR
 <p>MPC-50V</p> <p>PIR Occupancy/ Vacancy Sensor</p>	<p>Voltage: 120/277 VAC, 60 Hz Resistive: 10A Incandescent: 800W @ 120 VAC Electronic Ballast: 800 VA @ 120 VAC; 1600 VA @ 277 VAC Motor: 1/4 HP @ 120 VAC Coverage: 360°, 1200 sq. ft.</p>	MPC-50V	White
 <p>MPC-50VD</p> <p>PIR Occupancy Sensor with 0-10V Dimming</p>	<p>Voltage: 120/277 VAC, 50/60 Hz Resistive: 10A Electronic Ballast/LED: 800 VA @ 120 VAC; 1385 VA @ 277 VAC Load Rating: 2mA - 50mA Motor: 1/4 HP @ 120 VAC Coverage: 360°, 1200 sq. ft.</p>	MPC-50VD	White
 <p>MPC-52V</p> <p>Self-Contained PIR Occupancy Sensor 4 ft. Lead Cable</p>	<p>Voltage: 120/277 VAC, 60 Hz Resistive: 10A Incandescent: 800W @ 120 VAC Electronic Ballast: 800 VA @ 120 VAC; 1200 VA @ 277 VAC Motor: 1/4 HP @ 120 VAC Coverage: 360°, 800 sq. ft.</p>	MPC-52V	White
<p>Self-Contained PIR Occupancy Sensor 10 ft. Lead Cable</p>	<p>Voltage: 120/277 VAC, 60 Hz Resistive: 10A Incandescent: 800W @ 120 VAC Electronic Ballast: 800 VA @ 120 VAC; 1200 VA @ 277 VAC Motor: 1/4 HP @ 120 VAC Coverage: 360°, 800 sq. ft.</p>	MPC-52V10	White



## Line Voltage Sensors

### Features:

- Passive Infrared and Ultrasonic Technology
- High Bay Passive Infrared Technology (PIR)
- 360° Fresnel lens for superior occupancy detection
- Adjustable time delay and light level
- Vacancy override by using momentary switch (optional)
- "Walk-through" sensing mode increases energy savings by turning lights "OFF" shortly after momentary occupancy
- Works with fluorescent, LED high bays, and 0-10V dimming
- LED indicator light flashes when sensor detects motion to verify detection is active
- 2-year warranty

### Testing & Code Compliance:



### 360° Dual-Tech Line Voltage Ceiling Sensor



MDC-50V

DESCRIPTION	RATING	CAT. NO.	COLOR
Dual Technology PIR/ Ultrasonic Occupancy Sensor	Voltage: 120/277 VAC, 50/60 Hz Resistive: 6.6A Tungsten: 800W @ 120 VAC Electronic Ballast: 800 VA @ 120 VAC; 1600 VA @ 277 VAC Motor: 1/4 HP @ 120 VAC Coverage: 360° PIR Coverage: 1200 sq. ft. Ultrasonic Coverage: 1000 sq. ft.	MDC-50V	White

### 360° High Bay Ceiling Sensor



MPC-50H

DESCRIPTION	RATING	CAT. NO.	COLOR
High Bay PIR Occupancy Sensor Fixture Mount	Voltage: 120/277 VAC, 50/60 Hz Resistive: 10A Tungsten: 800W @ 120 VAC Electronic Ballast: 800 VA @ 120 VAC; 1200 VA @ 277 VAC VAC Motor: 1/4 HP @ 120 VAC Coverage: 360° MPC-50H - L1: 2800 sq. ft. MPC-50H - L2: 1200 sq. ft.	MPC-50H	White
High Bay PIR Occupancy Sensor with 0-10V Dimming Fixture Mount	Voltage: 120/277 VAC, 50/60 Hz Tungsten: 800W Resistive: 10A Electronic Ballast/LED: 800 VA @ 120 VAC; 1385 VA @ 277 VAC Load Rating: 2mA - 50mA Motor: 1/4 HP @ 120 VAC Coverage: 360° MPC-50H - L1: 2800 sq. ft. MPC-50H - L2: 1200 sq. ft.	MPC-50HD	White

## Line Voltage Sensors

### Features:

- Passive Infrared and Ultrasonic Technology
- 150° Fresnel lens for superior occupancy detection
- Adjustable time delay and light level
- Adjustable swivel neck rotates 80 degrees vertically and 60 degrees horizontally
- "Walk-through" sensing mode increases energy savings by turning lights "OFF" shortly after momentary occupancy
- Works with fluorescent and LED
- LED indicator light flashes when sensor detects motion to verify detection is active
- 2-year warranty

### Testing & Code Compliance:



### Line Voltage PIR Occupancy Wall Mount Sensor



MPW-V

DESCRIPTION	RATING	CAT. NO.	COLOR
PIR Occupancy Sensor Wall Mount	Voltage: 120 VAC, 50/60 Hz Resistive: 6.6A Tungsten: 800W @ 120 VAC Electronic Ballast: 800 VA @ 120 VAC Motor: 1/4 HP @ 120 VAC Coverage: 150°, 900 sq. ft.	MPW-V	White



MDW-V

### Line Voltage Dual-Tech Occupancy Wall Mount Sensor

DESCRIPTION	RATING	CAT. NO.	COLOR
Dual Technology PIR/ Ultrasonic Occupancy Sensor Wall Mount	Voltage: 120/277 VAC, 50/60 Hz Resistive: 6.6A Tungsten: 800W @ 120 VAC Electronic Ballast: 600 VA @ 120 VAC; 1385 VA @ 277 VAC Motor: 1/4 HP @ 120 VAC Coverage: 150° PIR Coverage: 1000 sq. ft. Ultrasonic: 800-1200 sq. ft.	MDW-V	White

## Low Voltage Sensors

### Features:

- Passive Infrared and Ultrasonic Technology
- 150° Fresnel lens for superior occupancy detection
- Adjustable time delay and light level
- Adjustable swivel neck rotates 80 degrees vertically and 60 degrees horizontally
- "Walk-through" sensing mode increases energy savings by turning lights "OFF" shortly after momentary occupancy
- Works with fluorescent and LED
- LED indicator light flashes when sensor detects motion to verify detection is active
- 2-year warranty

### Testing & Code Compliance:



### 150° Low Voltage PIR Occupancy Wall Mount Sensor



MPW-L

DESCRIPTION	RATING	CAT. NO.	COLOR
PIR Occupancy Sensor Requires MPP-24 Power Pack Wall Mount	Voltage: 22-26 VDC Current Consumption: 40mA Power Supply: MPP-24 Coverage: 150°, 900 sq. ft.	MPW-L	White

### 150° Low Voltage Dual-Tech Occupancy Wall Mount Sensor



MDW-L

DESCRIPTION	RATING	CAT. NO.	COLOR
Dual Technology PIR/Ultrasonic Occupancy Sensor Requires MPP-24 Power Pack Wall Mount	Voltage: 22-26 VDC Current Consumption: 40 mA Power Supply: MPP-24 Coverage: 150° PIR Coverage: 1000 sq. ft. Ultrasonic: 800 sq. ft.	MDW-L	White

## Low Voltage Sensors

### Features:

- Passive Infrared (PIR) Technology and Ultrasonic Technology
- 360° Fresnel lens for superior occupancy detection
- Full range 0-10V dimming daylight harvesting for a single zone
- Complies with ASHRAE 90.1, and Title 24, Part 6 occupancy/vacancy sensing
- Controls incandescent, CFL, LED and 0-10V dimming
- Adjustable delayed-OFF time setting between 5 seconds test mode to 30 minutes allows custom adjustment for maximum savings
- "Walk-through" sensing mode increases energy savings by turning lights "OFF" shortly after momentary occupancy
- Audible and visible alert
- LED indicator light flashes when sensor detects motion to verify detection is active
- 2-year warranty

### Testing & Code Compliance:



### Low Voltage Daylight Harvesting Sensor



MPL-010

DESCRIPTION	RATING	CAT. NO.	COLOR
Daylight Harvesting Sensor	Input Voltage: 12 - 24VDC Indoor Photocell Low Output: 0 VDC High Output: 10 VDC Foot Candle: 0-160FC Load Rating: 2mA - 50mA	MPL-010	White



MPC-50L

### 360° Low Voltage PIR Occupancy Ceiling Sensor

DESCRIPTION	RATING	CAT. NO.	COLOR
PIR Occupancy/Vacancy Sensor Requires MPP-24 Power Pack	Voltage: 24 VDC Current Consumption: 9 mA Coverage: 360°, 1200 sq. ft.	MPC-50L	White



MDC-50L

### 360° Low Voltage Dual-Tech Occupancy Ceiling Sensor

DESCRIPTION	RATING	CAT. NO.	COLOR
PIR and Ultrasonic Sensor Requires MPP 24 Power Pack	Voltage: 24 VDC Current Consumption: 20 mA Coverage: 360°, PIR Coverage: 1200 sq. ft. Ultrasonic Coverage: 1000 sq. ft.	MDC-50L	White

## Room Controls

### Features:

- 1-, 2-, 3-, and 4-button low voltage switch
- 1-2 load 0-10V dimmer switch
- Blue LED indicator on each button can be used as a locator light or as a status indicator
- Cat5 terminals
- Fits into decorator wall plates
- 2-year warranty



LVS-104-W



LVD-102-W



LV-Cat5

### Low Voltage Switches

DESCRIPTION	RATING	CAT. NO.	COLOR
Low Voltage Wall Switch, 1-Button w/LED	Input Voltage: 24 VDC maximum, from power pack Current Consumption: 20 mA	LVS-101	White
Low Voltage Wall Switch, 2-Button w/LED	Input Voltage: 24 VDC maximum, from power pack Current Consumption: 20 mA	LVS-102	White
Low Voltage Wall Switch, 3-Button w/LED	Input Voltage: 24 VDC maximum, from power pack Current Consumption: 20 mA	LVS-103	White
Low Voltage Wall Switch, 4-Button w/LED	Input Voltage: 24 VDC maximum, from power pack Current Consumption: 20 mA	LVS-104	White

### Low Voltage 0-10V Dimmer Switches

DESCRIPTION	RATING	CAT. NO.	COLOR
Low Voltage Wall Dimmer Switch, Single Load w/LED	Input Voltage: 24 VDC maximum, from power pack Current Consumption: 20 mA	LVD-101	White
Low Voltage Wall Dimmer Switch, Dual Load w/LED	Input Voltage: 24 VDC maximum, from power pack Current Consumption: 20 mA	LVD-102	White

### Low Voltage Cat5 Coupler

DESCRIPTION	RATING	CAT. NO.	COLOR
Cat5 Input/Output Device Provides Connection to LVD 0-10V Dimmer	2 RJ45 Connectors	LV-Cat5	White

## Power Pack and Adapters

### Features:

- Self-contained power supply/room control system
- Efficient switching power supply provides optimal current output to 6 sensors
- LED indicates status of relay, or if there is a low-voltage overcurrent
- Hold-to-on and hold-to-off inputs integrate with BMS, lighting control panels & other building systems
- Integrates with low-voltage momentary switch to control any 24VDC occupancy sensor
- 2-year warranty

### Testing & Code Compliance:



### Power Pack



MPP-24

DESCRIPTION	RATING	CAT. NO.	COLOR
Provides 24 VDC Operating Voltage to Enerlites Low-Voltage Occupancy Sensors, Switches, and Dimmers	Ballast: 20amp @120/230/240/277VAC, 50/60Hz Tungsten: 15amp @120VAC, 50/60Hz 5amp @250VAC, 50/60Hz Motor: 1HP @120/240VAC, 50/60Hz Output: 150mA @24VDC (with relay connected)	MPP-24	White

Power Supply by MPP-24 and Control Line Load through MPP-24  
Operating Temperature: 32°F to 131°F (0°C to 55°C)



MPC-A

### Adapters

DESCRIPTION	RATING	CAT. NO.	COLOR
Ceiling Sensor Flush Mount Adapter Surface Mounting Adapter for MPC Series Ceiling Sensors Compatible with Models: MPC-50V, MPC-50L, MDC-50V, and MDC-50L	4.5" diameter× 1" depth	MPC-A	White
Ceiling Sensor Surface Mount Adapter Compatible with Models: MPC-50V, MPC-50L, MDC-50V, MDC-50L Comes with a 1/2" Knockout, Washer, and Lock Nut	4.5" diameter× 1.5" depth	MPC-B	White
High Bay Ceiling Sensor Quick Installation Surface Mount Adapter Compatible with Models: MPC-50H, MPC-50HD Comes with Washer and Lock Nut	4.5" diameter× 1.5" depth	MPC-C	White
High Bay Ceiling Sensor Off-Set Adapter Compatible with Models: MPC-50H, MPC-50HD Comes with 3 Lock Nuts	4.24" length× 3.35 width	MPC-D	White



MPC-B



MPC-C

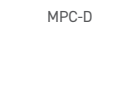

MPC-D

# Humidity Sensors

## Features:

- Passive infrared (PIR) and humidity sensing technology
- Lighting time delay: 10, 20, 30 minutes
- Fan time delay: 20 minutes
- Humidity set point: 45%-80% relative humidity
- Controls incandescent, CFL, and LED lighting
- 1/4 HP (3 Amp) fan
- Separate light and fan loads required
- Neutral wire required
- Interchangeable face cover
- 2-year warranty

## Testing & Code Compliance:



## Dual-Tech (Humidity and PIR Occupancy) Sensor Wall Switch



DWHOS-W

DESCRIPTION	RATING	CAT. NO.	COLOR
Single Pole 120 VAC 60 Hz Neutral Wire and Two Separate Loads Required	PIR Time Delay: 10, 20, and 30 minutes Resistive: 3A Tungsten: 500W Electronic Ballast/LED 400VA/400W Fan Time Delay: 20 minutes Humidity Set Point: 48%-80% relative humidity Motor: 1/4 HP PIR coverage: 600 sq. ft.	DWHOS	White



DWHS-W

## Humidity Sensor Wall Switch

DESCRIPTION	RATING	CAT. NO.	COLOR
Single Pole 120 VAC 60 Hz Neutral Wire Required	Fan Time Delay: 20 minutes Humidity Set Point: 45%-80% relative humidity 1/4 HP (3A) Fan	DWHS	White



DWHS-L-W

## Face Covers

DESCRIPTION	RATING	CAT. NO.	COLOR
Face Cover	-	DWHOS-L	Light Almond Black
Face Cover	-	DWHS-L	Light Almond Black

## Air Circulators & Fan Controls

### Features:

- Passive Infrared (PIR) and Fresh Air Circulator Technology
- Lighting time delay: 5-30 minutes
- Fan time delay: 5-60 minutes
- Fan auto mode time delay: 10-60 minutes
- Controls incandescent, CFL, and LED lighting
- 1/4 HP (3 Amp) fan
- Separate light and fan loads required
- Neutral wire required
- Interchangeable face cover
- 2-year warranty

### Testing & Code Compliance:



## Fresh Air Circulator and PIR Occupancy Sensor Wall Switch



DWTOS-W

DESCRIPTION	RATING	CAT. NO.	COLOR
Single Pole 120 VAC 60 Hz Neutral Wire and Two Separate Loads Required	Light Time Delay: 5-30 minutes Resistive: 3A Tungsten: 500W Electronic Ballast/LED: 400VA/150W Fan Time Delay: 5-60 minutes Fan Auto Mode: 10-60 minutes Motor: 1/4 HP Coverage: 180°, 600 sq. ft.	DWTOS	White



DWTOS-W

## Fresh Air Circulator Wall Switch

DESCRIPTION	RATING	CAT. NO.	COLOR
Single Pole 120 VAC 60 Hz Neutral Wire Required	Fan Time Delay: 5-60 minutes Fan Auto Mode: 10-60 minutes 1/4 HP (3 Amp) Fan	DWTOS	White



DWTOS-L-W

## Interchangeable Covers

DESCRIPTION	RATING	CAT. NO.	COLOR
Face Cover	4.24" length× 3.35 width	DWTOS-L	Light Almond Black
Face Cover	4.24" length× 3.35 width	DWTOS-L	Light Almond Black



**ENERLITES** plug load control devices offer high-quality control in a user-friendly package. The line includes both tamper-resistant and wireless control receptacles, which can connect to either a switch or ceiling sensor for extended appliance control.

## Wireless plug load controls

The PL20R and PLBPC help make plug load controls easy to implement, operate and comply with California Title 24 requirements. Plug Load Control requirements are being driven by expanded codes and standards with the common goal of energy efficiency. The Controlled Plug Load will turn ON when motion is detected by the ceiling sensor and will turn OFF 30 minutes after the room is vacated. The PIR ceiling sensor is battery operated so there is no need for expensive in-wall wiring between the sensor and receptacles.

# Plug Load Controls





## Wireless Plug Load Controls

### Features (PLBPC):

- Passive infrared technology
- Battery supplied power
- Easily mounts on ceilings with adhesive tape/mounting screws included
- 2-year warranty

### Features (PL20R):

- Back wired installation
- Each receptacle has its own unique code to ensure ease in set-up
- Compliant with 2017 NEC Article 406.12, ASHRAE Energy Efficiency Standard 90.1, and CA Title 24 when used in conjunction with PLBPC
- 2-year warranty

### Testing & Code Compliance:



### 360° Wireless Plug Load Control PIR Occupancy Ceiling Sensor



PLBPC

DESCRIPTION	RATING	CAT. NO.	COLOR
Plug Load Control Occupancy Sensor	Voltage: 2 AA batteries Frequency: 315 Mhz Time Delay: 30 min Coverage: 360°, 600 sq. ft.	PLBPC	White

### Wireless Control Plug Load Receptacle



PL20R-W

DESCRIPTION	RATING	CAT. NO.	COLOR
Plug Load Control Top Outlet Always ON Bottom is Controlled by PLBPC	Voltage: 20A 125 VAC Back wire terminal	PL20R	White

Programmable Digital  
Timer Switches **D2**

Preset Timer Switches **D3 - D4**

**ENERLITES** timers are designed to meet high quality and energy conservation standards. The category includes in-wall timer switches that feature either preset or programmable timer controls. They can precisely and conveniently turn lights and motor loads ON/OFF at the set or programmed time.

Programmable timers consist of a digital time display. Their simple design allows users to easily add, set, adjust, or apply a particular timing function. Programmable digital timers may include features such as daylight savings, random mode, and astronomic settings.

Countdown timer switches have no time display, and instead feature six preset timer buttons. This allows for several different timer options, all of which can be easily overridden with the manual ON/OFF button. Countdown timer switches are perfect for easily forgotten lights and appliances, such as in restrooms, pantries, or walk-in closets.

# Timer Switches

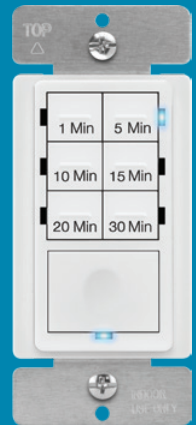

## Programmable Digital Timer Switches

### Features:

- Astronomic timer automatically adjusts dusk and dawn times
- 7 ON/OFF settings
- Automatically adjusts for daylight savings time
- Single pole or 3-way
- Programmable timers program up to 18 ON/OFF settings
- Random program function for security
- Manual override by pushing the door panel or ON/OFF button
- Back-lit LCD screen
- Works with CFL, incandescent, and LED bulbs
- Built-in battery pack stores program settings up to 14 days without power
- Neutral wire required
- 2-year warranty

### Testing & Code Compliance:



### Astronomic Digital Programmable In-Wall Timer Switch

DESCRIPTION	RATING	CAT. NO.	COLOR
Single Pole and 3-Way, Neutral Wire Required 120 VAC, 60 Hz	Resistive: 15A Tungsten: 1200W Standard Ballast: 1200 VA Electronic Ballast / LED: 5A (600W) Motor: 1/2HP	HET01-H1	White



HET01-H1-W

### 7-Day Digital Programmable In-Wall Timer Switch

DESCRIPTION	RATING	CAT. NO.	COLOR
Single Pole, Neutral Wire Required 120 VAC, 60 Hz	Resistive: 15A Tungsten: 1200W Standard Ballast: 1200VA Motor: 1/2 HP	HET01	White Ivory



HMT01N

### 24-Hour Mechanical In-Wall Timer Switch

DESCRIPTION	RATING	CAT. NO.	COLOR
Single Pole, 120 VAC, 60 Hz	Resistive: 15A Tungsten: 1250W Electronic Ballast: 500 VA Motor: 1/2 HP	HMT01N	White



## Preset Timer Switches

### Features:

- 7-button preset in-wall timers
- Replaces a standard light or fan single pole switch
- Works with CFL, incandescent, and LED bulbs
- Ideal for a closet, pantry, garage, laundry room, fan, heated towel rack, or for indoor/outdoor lighting
- 2-year warranty

### Testing & Code Compliance:



### 30-Minute 7-Button Preset Countdown Timer Switch, LED Always On

DESCRIPTION	RATING	CAT. NO.	COLOR
Single Pole, Neutral Wire Required 120 VAC, 60 Hz	Resistive: 6.4A Tungsten: 800W Electronic Ballast: 800 VA Motor: 1/4 HP	HET06A-R	White Ivory



HET06A-J-W

### 30-Minute 7-Button Preset Countdown Timer Switch

DESCRIPTION	RATING	CAT. NO.	COLOR
Single Pole, Ground Wire Required 120 VAC, 60 Hz	Resistive: 6.4A Tungsten: 800W Electronic Ballast: 800 VA Motor: 1/4 HP	HET06A-J	White



HET06-J6-W

### 60-Minute 7-Button Preset Countdown Timer Switch

DESCRIPTION	RATING	CAT. NO.	COLOR
Single Pole, Ground Wire Required 120 VAC, 60 Hz	Resistive: 6.4A Tungsten: 800W Electronic Ballast: 800 VA Motor: 1/4 HP	HET06-J6	White

## Preset Timer Switches

### Features:

- 7-button preset in-wall timers
- Replaces a standard light or fan single pole switch
- Works with CFL, incandescent, and LED bulbs
- Ideal for a closet, pantry, garage, laundry room, fan, heated towel rack, or for indoor/outdoor lighting
- 2-year warranty

### Testing & Code Compliance:



HET06-J-2H-W



HET06-J-W

### 2 Hour 7-Button Preset Countdown Timer Switch

DESCRIPTION	RATING	CAT. NO.	COLOR
Single Pole, Ground Wire Required 120 VAC, 60 Hz	Resistive: 6.4A Tungsten: 800W Fluorescent: 800VA Electronic Ballast: 800 VA Motor: 1/4 HP	HET06-J-2H	White

### 4 Hour 7-Button Preset Countdown Timer Switch

DESCRIPTION	RATING	CAT. NO.	COLOR
Single Pole, Neutral Wire Required 120 VAC, 60 Hz	Resistive: 15A Tungsten: 1000W Electronic Ballast: 1200 VA Motor: 1/2 HP	HET06-R	White Ivory
Single Pole, Ground Wire Required 120 VAC, 60 Hz	Resistive: 6.4A Tungsten: 800W Electronic Ballast: 800 VA Motor: 1/4 HP	HET06-J	White

### 12 Hour 7-Button Preset Countdown Timer Switch, LED Always On

DESCRIPTION	RATING	CAT. NO.	COLOR
Single Pole, Neutral Wire Required 120 VAC, 60 Hz	Resistive: 15A Tungsten: 1000W Standard Ballast: 1200 VA Electronic Ballast/LED: 5A or 600W Motor: 1/2 HP	HET06-12	White

LED Dimmer Switches

E2 - E3

Fan Speed Controls

E4

**ENERLITES** lighting dimmers and fan speed controllers are used to create the ideal atmosphere for any occasion. Dimmer switches and fan speed controllers are both designed to replace a standard wall switch and they allow the user complete control over light levels or ceiling fan speed.

We offer dimmer switches for both LED and incandescent lights, as well as combination switches for controlling both lights and fans from the same wall location. These devices offer both convenience and control, making them perfect for a range of residential and commercial applications.

# Dimmers & Fan Speed Controls

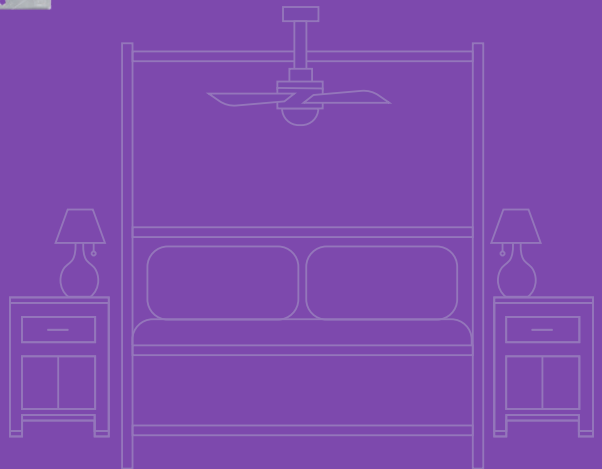
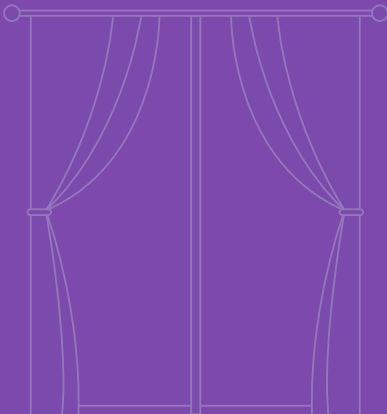

## LED Dimmers

### Features:

- Provides wider dimming range for dimmable LED and CFL bulbs than standard incandescent dimmers
- Suitable for multi-gang installations
- Dim lighting for increased energy savings
- Designed for compatibility with most high efficiency light bulbs
- Multi-location dimming when used with 58300-3K auxiliary switch
- 2-year warranty

### Testing & Code Compliance:



57302-W



58300-W

### LED Dimmer Switches

DESCRIPTION	RATING	CAT. NO.	COLOR
Single Pole Dimmable LED/CFL Incandescent 120 VAC, 60Hz	150W Dimmable LED/CFL 600W Incandescent	57302	White
Single Pole & 3-Way Dimmable LED/CFL Incandescent 120 VAC, 60Hz	150W Dimmable LED/CFL 600W Incandescent	58300	White

### LED Dimmer Auxiliary Switch

DESCRIPTION	RATING	CAT. NO.	COLOR
3-Way Add-On Switch Requires 58300 120 VAC, 60Hz	150W Dimmable LED/CFL 600W Incandescent	58300-3K	White





## LED Dimmers

### Features:

- Provides wider dimming range for dimmable LED and CFL bulbs than standard incandescent dimmers
- Suitable for multi-gang installations
- Dim lighting for increased energy savings
- Designed for compatibility with most high efficiency light bulbs
- 51300L dual voltage 120/277V for use with LED fixtures using 0-10V power supplies
- Single pole or 3-way functionality when used with a 3-way switch
- 2-year warranty

### Testing & Code Compliance:



## Dimmable LED, Halogen and Incandescent Dimmer Switches



51300-W



59302-W

DESCRIPTION	RATING	CAT. NO.	COLOR
Single Pole & 3-Way Slide Dimmer with Preset Switch 120 VAC, 60Hz	150W Dimmable LED/CFL 700W Incandescent	59302	White Light Almond Ivory
Single Pole & 3-Way Slide Dimmer with Large Switch 120 VAC, 60Hz	150W Dimmable LED/CFL 700W Incandescent	51300	White
Single Pole & 3-Way Vertical Slide Dimmer with Large Paddle 120 VAC, 60Hz	150W Dimmable LED/CFL 600W Incandescent	55300	White
Single Pole Dual LED Slide Dimmer 120 VAC, 60Hz	Load # 1: 300W Dimmable LED/CFL 300W Incandescent/Halogen Load # 2: 300W Dimmable LED/CFL 300W Incandescent/Halogen	57006 (17006)	White

## 0-10V Electronic Ballast LED Dimmer Switch

DESCRIPTION	RATING	CAT. NO.	COLOR
Single Pole & 3-Way Slide Dimmer with Large Switch 120-277 VAC, 60 Hz 120 VAC: 6A 277 VAC: 3A	Dimming Control 0-10V 30mA maximum sink current	51300L	White

## Fan Speed Controls

### Features:

- Dual sliders fan control and dimmer
- Single slider control
- Provides 3 quiet fan speeds for comfort
- Easy-to-use sliders allow you to control the fan speed and light level to adjust settings to your desired levels
- For use with decorator-style opening
- Right slide adjusts the light to your favorite level
- Works with dimmable CFL, incandescent, and LED bulbs
- 2-year warranty

### Testing & Code Compliance:



### 3-Speed Slide Fan Control and LED Dimmer Switch

DESCRIPTION	RATING	CAT. NO.	COLOR
Single Pole, Slide Fan Speed Control 120 VAC, 60 Hz	Dimmable LED/CFL: 150W Incandescent/Halogen: 360W Fan: 3-Speed Motor: 2.5A	17001-F3	White Light Almond Ivory



17001-F3-W

### 3-Speed Slide Fan Control Switch

DESCRIPTION	RATING	CAT. NO.	COLOR
Single Pole, Slide Fan Speed Control 120 VAC, 60 Hz	Fan: 3-Speed Motor: 2.5A	17000-F3	White Light Almond Ivory



17000-F3-W

### 3-Speed Rotary Fan Control Switch

DESCRIPTION	RATING	CAT. NO.	COLOR
Single Pole, Rotary Fan Speed Control 120 VAC, 60 Hz	Fan: 3-Speed Motor: 2.5A	17003	White Light Almond Ivory

Residential Grade	F3, F7
Commercial Grade	F4
Industrial Grade	F5, F8
Decorator Devices	F7
30 & 50 Amp Power Devices	F9
Surge Suppressors	F10

# Straight Blade Devices

**ENERLITES** offers a complete line of 15A, 20A, 30A, and 50A straight blade receptacles in residential, commercial, and industrial grades. The line includes standard and decorator receptacles, recessed receptacles, weather-resistant, tamper-resistant, surge suppressors, and heavy-duty receptacles designed for large appliances such as a kitchen range or an electric car.

Each straight blade device is precision-manufactured using the finest materials and tested to the highest standards to ensure a long service life and user-friendly design. All devices are design in compliance with the National Electric Code and various testing labs to ensure the highest quality and safety.



F  
F1

## Features and benefits:

- Excellent performance and longevity
- Permanent installation with continuous protection
- Tamper-resistant safety shutters on select devices
- Different wiring options to suit different applications
- A wide variety of colors with matching wall plate options
- All straight blade receptacles are UL listed



## Straight Blade Receptacles

Automatic grounding clip provides safe ground continuity between strap and metal enclosure - eliminates the need to use grounding jumper wire

Side located grounding screw backed out and ready to wire

Nut captures the wall plate and provides grounding and firm attachment of transformers or appliances



One-piece, triple-wipe brass line contacts superior design for minimum heat rise, maximum plug retention

Thick 1.2mm plated steel strap withstands abuse

Slotted and Phillips screw heads offer greater installation flexibility

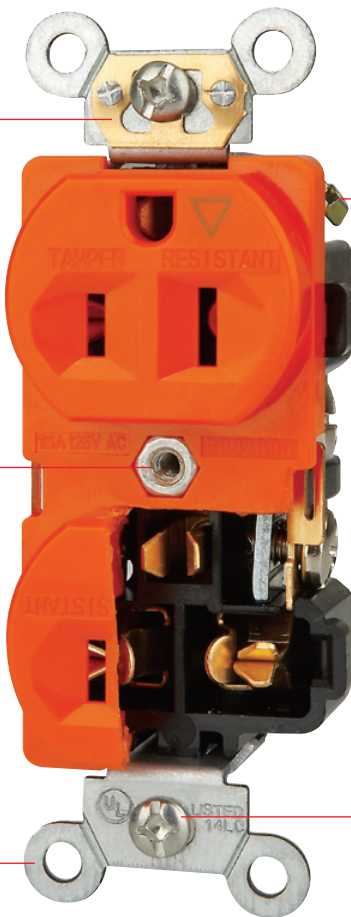

61510-0



## Residential Grade Receptacles

### Features:

- Made of thermoplastic material
- Tamper-resistant receptacle improves child safety – built-in shutter prevents access by most non-rated/foreign objects
- Optional grounding with self-grounding clip or green terminal screw
- Automatically ground to the metal outlet box
- Break-off tabs for easy two-circuit conversion
- Push-in #14 AWG Cu solid wire for 15A branch circuit only
- Shallow design for maximum wiring room
- Easy-access green hex head grounding screw
- Captive mounting screws
- Removable yoke tabs for ideal alignment
- Large head combination screws for fast wiring
- Terminal screws backed out ready for wiring
- Combination Slot/Phillips head mounting and terminal screws ease installation
- 2-year warranty

### Material Characteristics:

- Environmental: flammability UL94, V2 rating
- Operating temperatures: from -104°F (without impact) to 167°F maximum continuous

### Testing & Code Compliance:



## Residential Grade Duplex Receptacles Push-In and Side Wired



61580-W



61501-TRRP-W

Rating	15A-125V	20A-125V		
NEMA	 5-15R	 5-20R		
DESCRIPTION	CAT. NO.	CAT. NO.	COLOR	
Duplex Self-Grounding	61580	-	White Light Almond Ivory Gray	
Duplex, Tamper-Resistant Self-Grounding	61580-TR	62580-TR	White Light Almond Ivory Black Gray	
Duplex, Tamper and Weather-Resistant, Self-Grounding	61580-TWR	-	White Gray	

## Residential Grade Recessed Receptacles Push-In and Side Wired

Recessed Duplex Tamper-Resistant Decorator Receptacle	61501-TRRP	-	White
Clock Hanger, Recessed Single Tamper-Resistant Decorator Receptacle	61150-TRRP	-	White



## Commercial Grade Receptacles

### Features:

- Made of thermoplastic material
- Tamper-resistant receptacle improves child safety – built-in shutter prevents access by most non-rated/foreign objects
- Back and Side wired
- Shallow design for maximum wiring room
- Removable yoke tabs for ideal alignment
- Terminal screws backed out ready for wiring
- Combination Slot/Phillips head mounting and terminal screws ease installation
- 2-year warranty

### Material Characteristics:

- Environmental: flammability UL94, V2 rating
- Operating temperatures: from -104°F (without impact) to 167°F maximum continuous

### Testing & Code Compliance:



### Commercial Grade Duplex Receptacles Back and Side Wired

Rating	15A-125V	15A-250V	20A-125V	20A-250V	
NEMA					
	5-15R	6-15R	5-20R	6-20R	
DESCRIPTION	CAT. NO.	CAT. NO.	CAT. NO.	CAT. NO.	COLOR
Duplex, Self-Grounding	61540	-	62040	-	White Ivory Black
Duplex, Tamper-Resistant, Self-Grounding	61540-TR	-	62040-TR	-	White Light Almond Ivory Black Gray
	-	-	-	-	



### Commercial Grade Single Receptacles Side Wired

DESCRIPTION	CAT. NO.	CAT. NO.	CAT. NO.	CAT. NO.	COLOR
Single	61150	61160	61200	61210	White Ivory
Single, Tamper-Resistant	61150-TR	-	61200-TR	-	White Ivory Gray
	-	-	-	-	



### Commercial Grade Duplex TWR Receptacles Back Wired

DESCRIPTION	CAT. NO.	CAT. NO.	CAT. NO.	CAT. NO.	COLOR
Duplex, Weather and Tamper Resistant, Self-Grounding	-	-	62040-TWR	-	White Ivory Gray
	-	-	-	-	

### Commercial Grade Controlled Duplex Receptacles Back Wired

DESCRIPTION	CAT. NO.	CAT. NO.	CAT. NO.	CAT. NO.	COLOR
Duplex, Tamper-Resistant, Half Controlled Receptacle, Self-Grounding	61570-TR-PLH	-	62080-TR-PLH	-	White
	-	-	-	-	



## Industrial Grade Receptacles

### Features:

- Self-grounding clip
- Impact resistant thermoplastic cover and body
- Back wired
- Ground termination-brass strap version
- Break-off tabs for easy two-circuit conversion
- Two side barriers cover the wire terminals for insulation and isolation function (hospital grade only)
- Use only with 10AWG to 14AWG wires
- 2-year warranty

### Material Characteristics:

- Environmental: flammability UL94, V2 rating
- Operating temperatures: from -104°F (without impact) to 167°F maximum continuous

### Testing & Code Compliance:







## Industrial Grade Duplex Receptacles Back Wired



61510-0



68150-W

Rating	15A-125V	15A-250V	20A-125V	20A-250V	
NEMA	 5-15R	 6-15R	 5-20R	 6-20R	
DESCRIPTION	CAT. NO.	CAT. NO.	CAT. NO.	CAT. NO.	COLOR
Duplex, Self-Grounding	-	61571	62080	62081	White Ivory
Duplex, Tamper-Resistant Self-Grounding	61570-TR	-	62080-TR	-	White Ivory Gray
Duplex, Isolated Ground, Self-Grounding	- 61510	- 61610	62010	-	White Ivory Orange
Duplex, Tamper-Resistant, Isolated Ground, Self-Grounding	61510-TR	-	62010-TR	-	White Ivory
Hospital Grade Duplex Receptacles Back Wired					
DESCRIPTION	CAT. NO.	CAT. NO.	CAT. NO.	CAT. NO.	COLOR
Duplex Receptacle Self-Grounding	68150	68151	62020	62021	White Gray Orange Red
	-	-	-	-	
	-	-	-	-	



## Decorator Receptacles

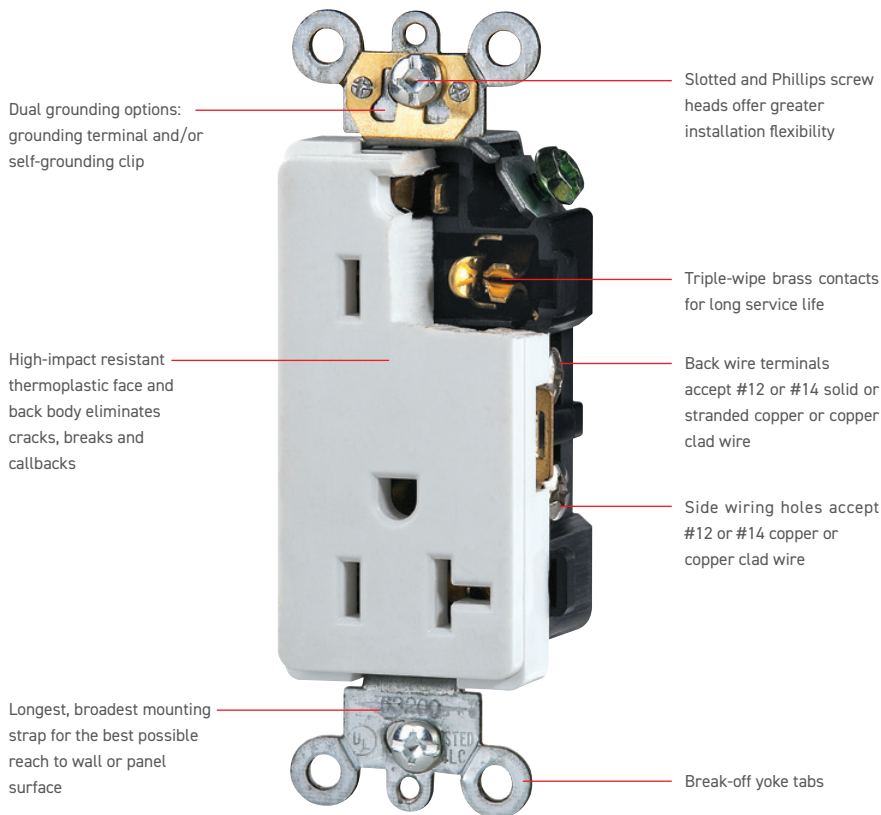

63200-W



How to connect wires to screw terminals



How to connect wires with back fitting





## Decorator Receptacles

### Features:

- Made of thermoplastic material
- Tamper-resistant receptacle improves child safety – built-in shutter prevents access by most non-rated/foreign objects
- Optional grounding with self-grounding clip or green terminal screw
- Break-off tabs for easy two-circuit conversion
- Push-in #14 AWG Cu solid wire for 15A branch circuit only
- Removable yoke tabs for ideal alignment
- Terminal screws backed out ready for wiring
- Combination Slot/Phillips head mounting and terminal screws ease installation
- Heavy-duty impact resistant thermoplastic construction for long service life in commercial applications
- Back wiring terminals accept both solid and stranded wire to ease installation
- 2-year warranty

### Material Characteristics:

- Environmental: flammability UL94, V2 rating
- Operating temperatures: from -104°F (without impact) to 167°F maximum continuous

### Testing & Code Compliance:



## Residential Grade Decorator Receptacles Push-In and Side Wired



Rating	15A-125V	20A-125V		
NEMA				
DESCRIPTION	CAT. NO.	CAT. NO.	COLOR	
Decorator, Self-Grounding	61501	62001	White Light Almond Ivory	
Decorator, Tamper-Resistant, Self-Grounding	61501-TR	62001-TR	White Light Almond Ivory Black Gray	
Decorator, Tamper and Weather Resistant, Self-Grounding	61501-TWR	-	White Gray	

## Commercial Grade Decorator Receptacles Back Wired

DESCRIPTION	CAT. NO.	CAT. NO.	COLOR
Decorator, Self-Grounding	-	62060	White
Decorator, Tamper-Resistant, Self-Grounding	-	62060-TR	White Ivory
Decorator, Tamper and Weather Resistant, Self-Grounding	-	62060-TWR	White Gray

## Commercial Grade Controlled Receptacles Back Wired

DESCRIPTION	CAT. NO.	CAT. NO.	COLOR
Decorator, Tamper-Resistant, Half Controlled Receptacle, Self-Grounding	63150-TR-PLH	63200-TR-PLH	White Gray



## Industrial Grade Receptacles

### Features:

- Self-grounding clip
- Impact resistant thermoplastic cover and body
- Tamper-resistant receptacle improves child safety – built-in shutter prevents access by most non-rated/foreign objects
- Back and side wired
- Ground termination-brass strap version
- Break-off tabs for easy two-circuit conversion
- Optional grounding with self-grounding clip or green terminal screw
- Use only with 10AWG to 14AWG wires
- 2-year warranty

### Material Characteristics:

- Environmental: flammability UL94, V2 rating
- Operating temperatures: from -104°F (without impact) to 167°F maximum continuous

### Testing & Code Compliance:



## Industrial Grade Decorator Receptacles Back Wired



63150-W



63200-W

Rating	15A-125V	15A-250V	20A-125V	20A-250V	
NEMA					
DESCRIPTION	CAT. NO.	CAT. NO.	CAT. NO.	CAT. NO.	COLOR
Decorator, Self-Grounding	63150	63151	63200	63201	White Ivory
Decorator, Tamper-Resistant, Self-Grounding	63150-TR	-	63200-TR	-	White Ivory Gray
Decorator, Isolated Ground, Self-Grounding	61500-IG	61550-IG -	62000-IG	62050-IG	White Ivory Orange
Decorator, Tamper-Resistant, Isolated Ground, Self-Grounding	61500-IG-TR	- - -	62000-IG-TR	- - -	White Ivory Orange



## 30 & 50 Amp Power Devices

### Features:

- Made of thermoplastic material
- Heavy gauge steel mounting strap zinc-plated for corrosion resistance
- Flush receptacles fit one or two gang enclosures
- Terminal markings for easy identification and quick cabling
- Large head combination screws for fast wiring
- Ratings and NEMA I.D. permanently marked on device
- 2-year warranty

### Material Characteristics:

- Environmental: flammability UL94, V2 rating

### Testing & Code Compliance:



Rating	Receptacle/Plug Configuration & NEMA No.		Flush Mount Receptacle	Angle Plug	Power Adapter	Color
<b>2-Pole, 3-Wire, Grounding</b>						
30A-125V For Recreation Vehicles	TT-30R 	TT-30P 	63300	-	69354 / 69554	Black
30A-250V	6-30R 	6-30P 	65300	65351	-	Black
50A-250V	6-50R 	6-50P 	65500	65351	65352	Black
<b>3-Pole, 3-Wire, Non-Grounding</b>						
<b>30A-125V/250V</b>	10-30R 	10-30P 	<b>67300</b>	67351	-	<b>Black</b>
<b>50A-125V/250V</b>	10-50R 	10-50P 	<b>67500</b>	67351	-	<b>Black</b>
<b>3-Pole, 4-Wire, Grounding</b>						
<b>30A-125V/250V</b>	14-30R 	14-30P 	<b>66300</b>	66351 -	- -	<b>Black</b> White
50A-125V/250V	14-50R 	14-50P 	66500	66351 -	66352 -	Black White



## Surge Suppressors

### Features:

- 15A/20A, 125 VAC surge suppressed outlets
- Tamper-resistant shutters
- LED indicators for real time monitoring of grounding and surge suppression
- Two outlets: multi-line surge suppression (L-N, L-G, and N-G)
- Easily replace standard receptacles
- 900 joules of protection
- 2-year warranty



### Material Characteristics:

- Environmental: flammability UL94, V2 rating
- Operating temperatures: from -104°F (without impact) to 167°F maximum continuous

### Testing & Code Compliance:



### Surge Suppressor Back and Side Wired

Rating	15A-125V	20A-125V		
NEMA	 5-15R	 5-20R		
DESCRIPTION	CAT. NO.	CAT. NO.	COLOR	
Surge Suppressor Tamper-Resistant	61501-TRSS	62001-TRSS	White Black	



61501-TRSS-W



62001-TRSS-W

### Type 3 Point-of-Use

### Type 3 Surge Protective Devices

Type 3 SPDs are point of utilization SPDs, installed at a minimum conductor length of 10 meters (30 feet) from the electrical service panel to the point of utilization. Examples include cord connected, direct plug-in, receptacle type and SPDs installed at the utilization equipment being protected. The distance (10 meters) is exclusive of conductors provided with or used to attach SPDs.

Enlites Surge Suppressors with two outlets protect your PC, personal computer, home/office electronics and more from dangerous power surges, spikes & line noise. Ideal for residential, commercial and institutional applications. They are the preferred choice of electricians and contractors.

Toggle Switches

G2 - G3

Decorator Switches

G4 - G5

# Switches

**ENERLITES** provides a comprehensive line of toggle and decorator style switches, with variations designed for single-pole, three-way, and four-way applications.

These switches can replace a standard wall switch for an immediate upgrade. A full selection is available in residential, commercial, and industrial grades. Enerlites wall switches are manufactured to high quality standards and thoroughly tested to ensure flawless electrical and mechanical performance.



## Toggle Switches

### Features:

- Made of thermoplastic material
- Faster installation with combination of side wiring and push-in wiring
- Push-in terminals accept #14 solid wire only
- Easy-access green hex head ground screw
- Steel mounting strap, made of galvanized steel for corrosion resistance
- Removable yoke tabs for ideal alignment
- Large head combination screws for fast wiring
- 2-year warranty

### Material Characteristics:

- Environmental: flammability UL94, V2 rating
- Operating temperatures: from -104°F (without impact) to 167°F maximum continuous

### Testing & Code Compliance:



### Residential Grade Toggle Switches Push-In and Side Wired

DESCRIPTION	CAT. NO.	COLOR
Single Pole 15A 120/277 VAC	88115	White Light Almond Ivory Gray
3-Way 15A 120/277 VAC	83150	White Light Almond Ivory Gray



88115-W

### Residential Grade Toggle Switches Side Wired

DESCRIPTION	CAT. NO.	COLOR
4-Way 15A 120/277 VAC	84150	White Ivory



83150L-C

### Residential Grade Toggle Switches Push-In and Side Wired - Lighted

DESCRIPTION	CAT. NO.	COLOR
Single Pole 15A 120/277 VAC	88115L	White Clear
3-Way 15A 120/277 VAC	83150L	White Clear



81200-W

### Commercial Grade Toggle Switches Side Wired

DESCRIPTION	CAT. NO.	COLOR
Single Pole Self-Grounding 20A 120/277 VAC	81200	White Ivory Gray
3-Way Self-Grounding 20A 120/277 VAC	83200	White Ivory

## Toggle Switches

### Features:

- 120/277V rating ideal for fluorescent lighting fixtures typical in commercial applications
- Side wired terminals; use 12 or 14 AWG copper wires only
- Large head double-drive combination screws (Standard, Phillips) for fast wiring
- Removable yoke tabs for ideal alignment
- Pilot Light - Illuminated ON - Load ON
- 2-year warranty

### Material Characteristics:

- Environmental: flammability UL94, V2 rating
- Operating temperatures: from -104°F (without impact) to 167°F maximum continuous

### Testing & Code Compliance:



### Commercial Grade Heavy Duty Toggle Switches Back and Side Wired



84201-W

DESCRIPTION	CAT. NO.	COLOR
Single Pole Self-Grounding 20A 120/277 VAC	81201	White Light Almond Gray
3-Way Self-Grounding 20A 120/277 VAC	83201	White Light Almond Gray
4-Way Self-Grounding 20A 120/277 VAC	84201	White Light Almond Gray



82300-W

### Commercial Grade Heavy Duty Double Pole Toggle Switches Back and Side Wired

DESCRIPTION	CAT. NO.	COLOR
Double Pole Self-Grounding 20A 120/277 VAC	82200	White Ivory Black
Double Pole Self-Grounding 30A 120/277 VAC	82300	White Ivory Black

### Commercial Grade Heavy Duty Pilot Light Toggle Switches Back and Side Wired

DESCRIPTION	CAT. NO.	COLOR
Double Pole Illuminate ON Self-Grounding 20A 120/277 VAC	82200-PL	Red
Double Pole Illuminate ON Self-Grounding 30A 120/277 VAC	82300-PL	Red

## Decorator Switches

### Features:

- Smooth, quiet paddle action
- Narrow body leaves more room for wires in the box
- High-impact resistant thermoplastic construction
- Removable yoke tabs for ideal alignment
- Captive mounting screws
- Push-in terminals for quick installation
- Easy-access green hex head ground screw
- Various colors available
- 2-year warranty

### Material Characteristics:

- Environmental: flammability UL94, V2 rating
- Operating temperatures: from -104°F (without impact) to 167°F maximum continuous

### Testing & Code Compliance:



91150-W

### Residential Grade AC Quiet Decorator Switches Push-In and Side Wired

DESCRIPTION	CAT. NO.	COLOR
<b>Single Pole</b> <b>Self-Grounding</b> <b>15A 120/277 VAC</b>	91150	<b>White</b> Light Almond <b>Ivory</b> <b>Black</b> Gray
<b>3-Way</b> <b>Self-Grounding</b> <b>15A 120/277 VAC</b>	93150	<b>White</b> Light Almond <b>Ivory</b> Black Gray



94150-W

### Residential Grade AC Quiet Decorator Switches Side Wired

DESCRIPTION	CAT. NO.	COLOR
<b>4-Way</b> <b>15A 120/277 VAC</b>	94150	<b>White</b> Light Almond Ivory Black Gray



## Decorator Switches

### Features:

- Smooth, quiet paddle action
- Narrow body leaves more room for wires in the box
- High-impact resistant thermoplastic construction
- Removable yoke tabs for ideal alignment
- Captive mounting screws
- Push-in terminals for quick installation
- Easy-access green hex head ground screw
- Various colors available
- 2-year warranty

### Material Characteristics:

- Environmental: flammability UL94, V2 rating
- Operating temperatures: from -104°F (without impact) to 167°F maximum continuous

### Testing & Code Compliance:



91160-W

### Residential Grade Decorator Switches Push-In and Side Wired - Lighted

DESCRIPTION	CAT. NO.	COLOR
Single Pole 15A 120/277 VAC	91160	White Light Almond Ivory Gray
3-Way 15A 120/277 VAC	93160	White Light Almond Ivory Gray

### Commercial Grade Decorator Switches Push-In and Side Wired - Momentary Switch

DESCRIPTION	CAT. NO.	COLOR
Single Pole 15A 120/277 VAC	91245	White Ivory



91200-W

### Commercial Grade Decorator Switches Side Wired

DESCRIPTION	CAT. NO.	COLOR
Single Pole Self-Grounding 20A 120/277 VAC	91200	White Light Almond Ivory Black Gray
3-Way Self-Grounding 20A 120/277 VAC	93200	White Light Almond Ivory Black Gray

# Combination Devices

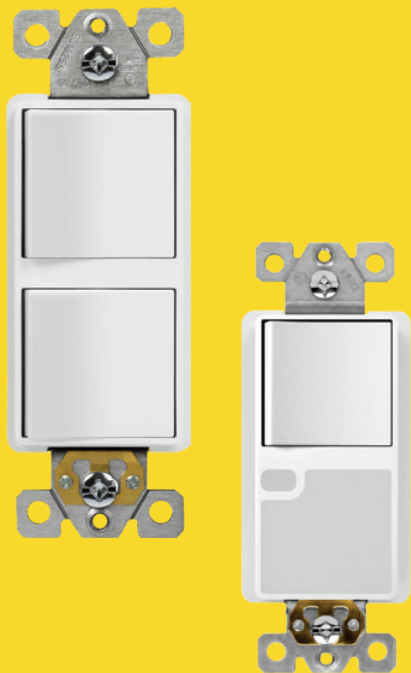

Combination Devices H2

Guide Light Devices H3

**ENERLITES** provides a comprehensive line of 15A and 20A combination devices, which offer multifunctionality in a compact package.

These single-gang in-wall devices can replace a standard light switch or outlet to offer additional features. The line includes double and triple light switches, switch/outlet combination devices, and guide light devices.

Combination devices offer enhanced convenience and help users save space, making them perfect for most residential and commercial applications.

E  
H1

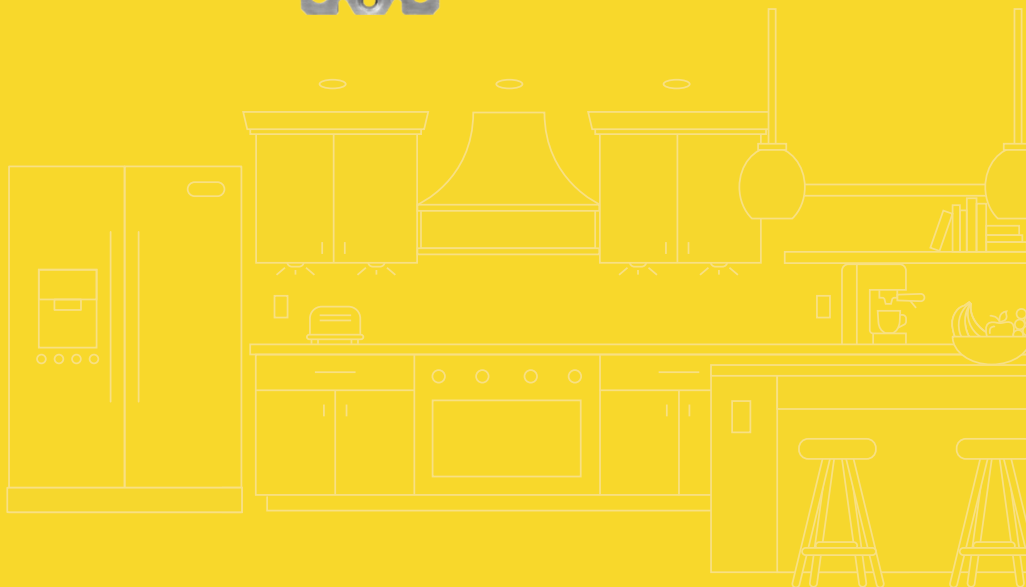



## Combination Devices

### Features:

- Terminal screws backed out ready for wiring
- Side wire terminals; use 12 or 14 AWG copper wires only
- Optional grounding with self-grounding clip or green terminal screw
- All devices fit standard wall boxes
- 2-year warranty

### Material Characteristics:

- Environmental: flammability UL94, V2 rating
- Operating temperatures: from -104°F (without impact) to 167°F maximum continuous

### Testing & Code Compliance:



82150-W

### Combination Devices Back and Side Wired

DESCRIPTION	CAT. NO.	COLOR
Two Single Pole Switches Self-Grounding Switch:15A 120 VAC	82150	White Gray
Single Pole Switch/Pilot Light Switch:15A 120 VAC	82150L	White Ivory
Single Pole Switch/ Tamper-Resistant Receptacle Self-Grounding Switch:15A 120 VAC Receptacle: 15A 125 VAC	62150-TR	White Gray



68625-TR-GY

### Combination Decorator Devices Back and Side Wired

DESCRIPTION	CAT. NO.	COLOR
Two Single Pole Switches Self-Grounding Switch:15A 120 VAC	62834	White Light Almond Ivory Black Gray
Two 3-Way Switches Self-Grounding Switch:15A 120 VAC	62835	White Light Almond Ivory Black Gray
Triple Rocker Switches Self-Grounding Switch:15A 120 VAC	62755	White Light Almond Ivory Gray
Single Pole Switch/ Tamper-Resistant Receptacle Self-Grounding Switch:15A 120 VAC Receptacle: 15A 125 VAC	68625-TR	White Gray



## Guide Light Devices

### Features:

- Clearly visible "TR" markings on the face of device
- High-impact resistant thermoplastic cover and body for long service life in commercial applications
- Green grounding screw and self-grounding clip for automatic grounding connection in grounded metal wall box
- Shallow design for maximum wiring room in box
- Removable yoke tabs for ideal alignment
- Various colors available
- 2-year warranty

### Material Characteristics:

- Environmental: flammability UL94, V2 rating
- Operating temperatures: from -104°F (without impact) to 167°F maximum continuous

### Testing & Code Compliance:



### Guide Light Receptacles Side Wired

DESCRIPTION	CAT. NO.	COLOR
Decorator Tamper-Resistant Receptacle with Guide Light 15A 125 VAC	61501-TRGL	White



61501-TRGL-W

### Guide Light Switches Side Wired

DESCRIPTION	CAT. NO.	COLOR
Single Pole Switch with Guide Light Self-Grounding 15A 120 VAC	91150-GL	White
3-Way Switch with Guide Light Self-Grounding 15A 120 VAC	93150-GL	White
Full Guide Light 15A 120 VAC	91000-GL	White



91150-GL-W



NEMA 15 & 20 Amp Locking Devices	13
NEMA 30 Amp Locking Devices	14
Straight Blade Devices	15

# Locking Devices

**ENERLITES** industrial-grade locking devices provide unparalleled quality alongside superb performance in the most physically demanding environments. The line includes a comprehensive selection of locking plugs and receptacles, flanged inlets/outlets, and connectors.

Available in 15A, 20A, and 30A variations, we offer locking devices in a wide range of configurations to suit virtually any industrial application.

**Features and benefits:**

- Durable and cost efficient
- Ease-of-use for do-it-yourself installation
- All locking devices are UL listed



E  
11



## Industrial Grade Locking Receptacles, Plugs

High-impact resistant thermoplastic construction stands up to severe job site abuse

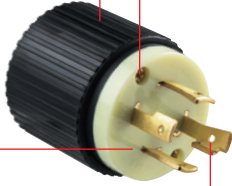

Rating, voltage and NEMA line number imprinted on face

Captive, combination Phillips/Slotted assembly screws

Solid brass blades are fitted and held tightly and securely in place

Heavy-duty mounting straps are nickel-plated to resist corrosion



NEMA line number and rating are molded into face for easy identification

High-impact resistant nylon face and body

## Industrial Grade Locking Flanged Inlets, Flanged Outlets, and Connectors

The nylon housing of insulated design shields exposed metal parts on hand-held side



The industrial strength contacts resist heat rise, provide excellent conductivity

The nylon housing of insulated design shields exposed metal parts on hand-held side



Amperage, voltage and NEMA line number imprinted on face for easy identification

High-impact resistant thermoplastic construction



Captive, combination Phillips/slotted assembly screws

















## NEMA 15 & 20 Amp Locking Devices

### Features:

- Clearly marked rating, NEMA configuration, and approval listings on device face
- Locking plugs feature heavy-duty construction for top performance in the environment
- 2-year warranty

### Testing & Code Compliance:



Rating	Receptacle/Plug Configuration & NEMA No.	Receptacle	Plug	Connector	Flange Inlet	Flange Outlet	Color
<b>2-Pole, 3-Wire, Grounding</b>							
15A 277V, L7-15	L7-15R 	L7-15P 	66480	66481	66482	-	Black
20A 125V, L5-20	L5-20R 	L5-20P 	66400 -	66401 -	66402 -	- 66403	Black White
20A 250V, L6-20	L6-20R 	L6-20P 	66410 -	66411 -	66412 -	- 66413	Black White
20A 277V, L7-20	L7-20R 	L7-20P 	66510	66511	66512	-	Black
<b>3-Pole, 4-Wire, Grounding</b>							
20A 125/250V, L14-20	L14-20R 	L14-20P 	66420 -	66421 -	66422 -	- 66423	Black White
20A 125/250V, L15-20	L15-20R 	L15-20P 	66900 -	66901 -	66902 -	- 66903	Black White
<b>4-Pole, 5-Wire, Grounding</b>							
20A 120/208V, L21-20	L21-20R 	L21-20P 	66602	66600	66601	-	Black









## NEMA 30 Amp Locking Devices

### Features:

- Clearly marked rating, NEMA configuration, and approval listings on device face
- Locking plugs feature heavy-duty construction for top performance in the environment
- 2-year warranty

### Testing & Code Compliance:



Rating	Receptacle/Plug Configuration & NEMA No.		Receptacle	Plug	Connector	Flange Inlet	Flange Outlet	Color
<b>2-Pole, 3-Wire, Grounding</b>								
30A 125V, L5-30	L5-30R 	L5-30P 	66440 -	66450 -	66452 -	- 66453	- 66454	Black White
30A 250V, L6-30	L6-30R 	L6-30P 	66460 -	66461 -	66462 -	- 66463	- 66464	Black White
<b>3-Pole, 4-Wire, Grounding</b>								
30A 125/250V, L14-30	L14-30R 	L14-30P 	66490 -	66470 -	66492 -	- 66493	- 66494	Black White
30A 125/250V, L15-30	L15-30R 	L15-30P 	66801 -	66800 -	66802 -	- 66803	- 66804	Black White











## Straight Blade Devices

### Features:

- Clearly marked rating, NEMA configuration and approval listings on device face
- Plugs and connectors feature heavy-duty construction for top performance in the environment
- 2-year warranty

### Testing & Code Compliance:



Rating	Receptacle/Plug Configuration & NEMA No.	Combo	Plug	Connector	Flange Inlet	Flange Outlet	Color
<b>2-Pole, 3-Wire, Grounding</b>							
15A, 125V	 5-15P	-	66200	66201	-	-	Black
		-	-	-	66203	66204	White
15A, 125V	 5-15P	66212 Plug and Connector Combo	-	-	-	-	Yellow
15A, 125V	 5-15P	-	-	-	66215 15A RV Power Flanged Inlet with 22" AC Cable	-	Black
20A, 125V	 5-20P	-	66210	66211	-	-	Black
		-	-	-	66213	66214	White
20A, 125V	 5-20P	-	-	-	66205 20A RV Power Flanged Inlet with 22" AC Cable	-	Black
15A, 250V	 6-15P	-	66220	66221	-	-	Black
		-	-	-	66223	66224	White
20A, 250V	 6-20P	-	66230	66231	-	-	Black
		-	-	-	66233	66234	White

# Floor Boxes & Covers

Flush Floor Boxes	J2
Pop-Up Floor Boxes	J3 - J4
Floor Box Covers	J4
Floor Box Flanges	J5
Junction Boxes & Accessories	J5

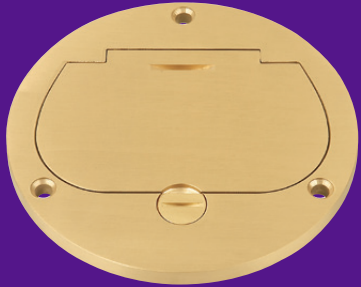

**ENERLITES** floor boxes are ideal for bringing power and communication into commercial and residential buildings. Designed with a metal cover that protects the receptacle from everyday foot traffic, these floor boxes are perfect for a variety of installations. Features include USB charging ports, GFCI outlets with watertight gaskets, and corrosive-resistant hardware. Backed by cutting-edge design and manufacturing, Enerlites floor boxes blend seamlessly into their environments.

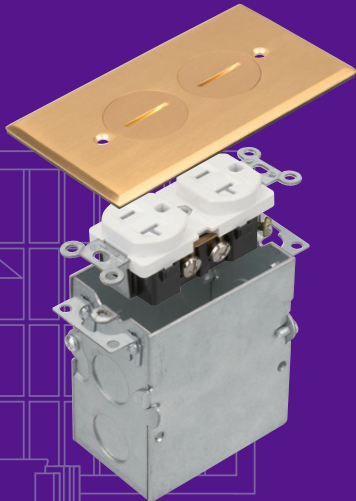



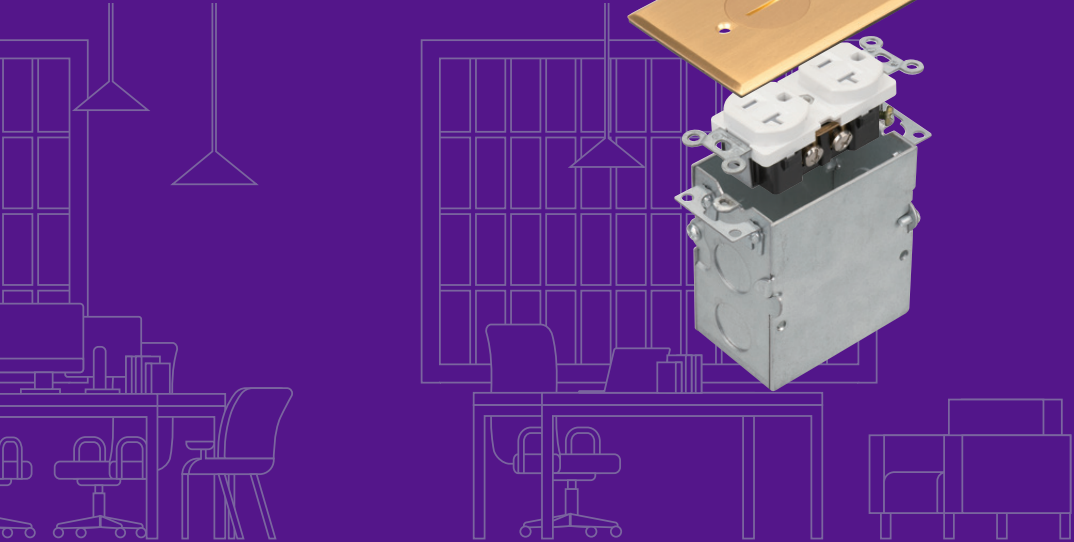



J1











## Flush Floor Boxes

### Flush Rectangular One-Gang Floor Boxes



	DESCRIPTION	CAT. NO.	FINISH	DIMENSIONS
 	One-Gang Floor Box Kit with 20A Duplex Tamper & Weather Resistant Receptacle	975506-C 975506-SS	Brass Stainless Steel	5"×2-7/8" (127×73mm)
 	One-Gang Floor Box Kit with Flip Lid Cover, 20A Duplex Tamper & Weather Resistant Receptacle	975507-C 975507-S	Brass Nickel-Plated Brass	5"×2-7/8" (127×73mm)
 	One-Gang Floor Box Kit with 20A Single Tamper-Resistant Receptacle	975547-C 975547-SS	Brass Stainless Steel	5"×2-7/8" (127×73mm)

### Flush Square Two-Gang Floor Boxes

	DESCRIPTION	CAT. NO.	FINISH	DIMENSIONS
 	Two-Gang Floor Box Kit with 20A Duplex Tamper & Weather Resistant Receptacle	975510-C 975510-SS	Brass Stainless Steel	5"×5" (127×127mm)
 	Two-Gang Floor Box Kit with 20A Duplex Tamper & Weather Resistant Receptacle and Datacom	975510-C-D 975510-SS-D	Brass Stainless Steel	5"×5" (127×127mm)
 	Two-Gang Floor Box Kit with Flip Lid Cover, 20A Duplex Tamper & Weather Resistant Receptacle	975549-C 975549-S	Brass Nickel-Plated Brass	5"×5" (127×127mm)
 	Two-Gang Floor Box Kit with Flip Lid Cover, 20A Duplex Tamper & Weather Resistant Receptacle and Datacom	975549-C-D 975549-S-D	Brass Nickel-Plated Brass	5"×5" (127×127mm)

\* All receptacles are tamper-resistant, UL listed

## Pop-Up Floor Boxes



Round Floor Boxes			
DESCRIPTION	CAT. NO.	FINISH	DIMENSIONS
 Round Pop-Up Floor Box Kit with 20A Decorator Duplex Tamper & Weather Resistant Receptacle	961501-C 961501-S	Brass Nickel-Plated Brass	Ø6" (Ø150mm)
 Round Pop-Up Floor Box Kit with 2.1A USB Charger	961501-C-USB 961501-S-USB	Brass Nickel-Plated Brass	Ø6" (Ø150mm)
 Round Pop-Up Floor Box Kit with 20A GFCI Receptacle	961501-C-GFCI 961501-S-GFCI	Brass Nickel-Plated Brass	Ø6" (Ø150mm)

Square Floor Boxes			
DESCRIPTION	CAT. NO.	FINISH	DIMENSIONS
 Square Pop-Up Floor Box Kit with 20A Decorator Duplex Tamper & Weather Resistant Receptacle	961241-C 961241-S	Brass Nickel-Plated Brass	4-3/4"×4-3/4" (120×120mm)
 Square Pop-Up Floor Box Kit with 20A Decorator Duplex Tamper & Weather Resistant Receptacle	961243-C	Brass	4-3/4"×4-3/4" (120×120mm)
 Square Pop-Up Floor Box Kit with 2.1A USB Charger	961243-C-USB 961243-S-USB	Brass Nickel-Plated Brass	4-3/4"×4-3/4" (120×120mm)
 Square Pop-Up Floor Box Kit with 20A GFCI Receptacle	961243-C-GFCI 961243-S-GFCI	Brass Nickel-Plated Brass	4-3/4"×4-3/4" (120×120mm)
 Square Soft Pop-Up Floor Box Kit with 4.0A USB Charger Receptacle	961248-C-USB 961248-S-USB	Brass Nickel-Plated Brass	5"×5-1/2" (127×140mm)
 Square Soft Pop-Up Floor Box Kit with 20A GFCI Receptacle	961248-C-GFCI 961248-S-GFCI	Brass Nickel-Plated Brass	5"×5-1/2" (127×140mm)

\* All receptacles are tamper-resistant, UL listed





## Pop-Up Floor Boxes

Dual Receptacles Rectangular Pop-Up Floor Boxes			
DESCRIPTION	CAT. NO.	FINISH	DIMENSIONS
 Two-Gang Pop-Up Floor Box Kit with 20A Decorator Duplex Tamper & Weather Resistant Receptacle	962301-C	Brass	8-11/16"×4-3/4" (220×120mm)
	962301-S	Nickel-Plated Brass	
 Two-Gang Pop-Up Floor Box Kit with 20A Decorator Duplex Tamper & Weather Resistant Receptacle and RJ45	962301-C-D	Brass	8-11/16"×4-3/4" (220×120mm)
	962301-S-D	Nickel-Plated Brass	

\* All receptacles are tamper-resistant, UL listed

## Floor Box Covers

Floor Box Covers			
DESCRIPTION	CAT. NO.	FINISH	DIMENSIONS
 4" Dia. Flush Round Cover Plate with 20A Duplex Tamper & Weather Resistant Receptacle	975501-C	Brass	φ4" (φ101.6mm)
	975501-S	Nickel-Plated Brass	
	975501-SS	Stainless Steel	
 4" Dia. Flush Round Flip Lid Cover Plate with 20A Duplex Tamper & Weather Resistant Receptacle	975502-C	Brass	φ4" (φ101.6mm)
	975502-S	Nickel-Plated Brass	
 4" Dia. Flush Round Dual Flip Lid Cover Plate with 20A Duplex Tamper & Weather Resistant Receptacle	975503-C	Brass	φ4" (φ101.6mm)
	975503-S	Nickel-Plated Brass	
 5-1/2" Dia. Flush Round Cover Plate with 20A Duplex Tamper & Weather Resistant Receptacle	975516-SS	Stainless Steel	Φ5-1/2" (Φ140mm)
 5-3/4" Dia. Flush Round Flip Lid Cover Plate with 20A Duplex Tamper & Weather Resistant Receptacle	975517-C	Brass	Φ5-3/4" (Φ146mm)
	975517-S	Nickel-Plated Brass	
 5-1/2" Dia. Flush Round Cover Plate with 20A Duplex Tamper & Weather Resistant Receptacle	975519-C	Brass	Φ5-1/2" (Φ140mm)
	975519-S	Nickel-Plated Brass	



## Floor Box Flanges

Floor Box Flanges				
DESCRIPTION	CAT. NO.	FINISH	DIMENSIONS	
	4-1/4" Dia. Round Flange	975509-C 975509-S	Brass Nickel-Plated Brass	Φ4-1/4" (Φ108mm)
	5-1/4" Dia. Round Flange	975518-C 975518-S	Brass Nickel-Plated Brass	Φ5-1/4" (Φ132.5mm)

## Junction Boxes and Accessories

Junction Boxes and Accessories			
DESCRIPTION	CAT. NO.	FINISH	DIMENSIONS
	ENLC001	PVC	5" dia (Φ127mm) 6" deep (Φ152.4mm)
	ENLC001AR	PVC	Outer diameter: 4.6" Inner diameter: 4.25" Depth: 1.5"
	ENLC001LR	PVC	Outer diameter: 4.6" Inner diameter: 4.25" Depth: 1.5"
	FB-02	Galvanized Metal	4.69-in × 4.69-in × 3-in (L × W × H)

\* ENLC001AR is compatible with 961501-C and 961501-S

\* ENLC001LR is compatible with 975516-S, 975516-C, 975517-S, 975517-C, 975519-S, 975519-C, 975501-SS and 975501-C

Audio/ Video Connectors	K2
Decorator Adapters	K3
Multimedia Wall Plates	K4
Recessed Cable Plates	K5
Molded-In Voice & Audio/Video	K6
Telephone Wall Jacks	K7
Telephone & CATV Jacks	K8

# Data-Com Devices & Wall Plates

**ENERLITES** offers a complete line of data-com devices and wall plates for reliable, cabled connections. The line includes single and multi connectors as well as integrated wall jacks, pass-through wall plate inserts, keystone ports and modules, and various data-com wall plates.

Mix and match any keystone or simply select the right insert or wall jack to fit your needs. You can always count on cabled connections if your business activity or home entertainment relies on an uninterrupted server connection.

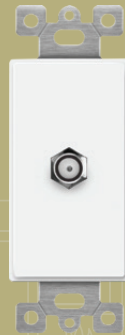
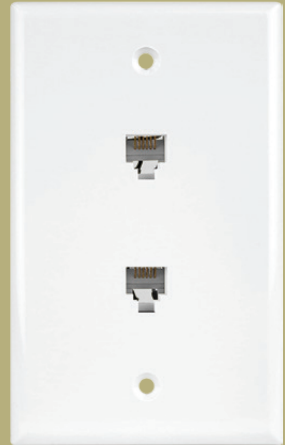

E  
K1

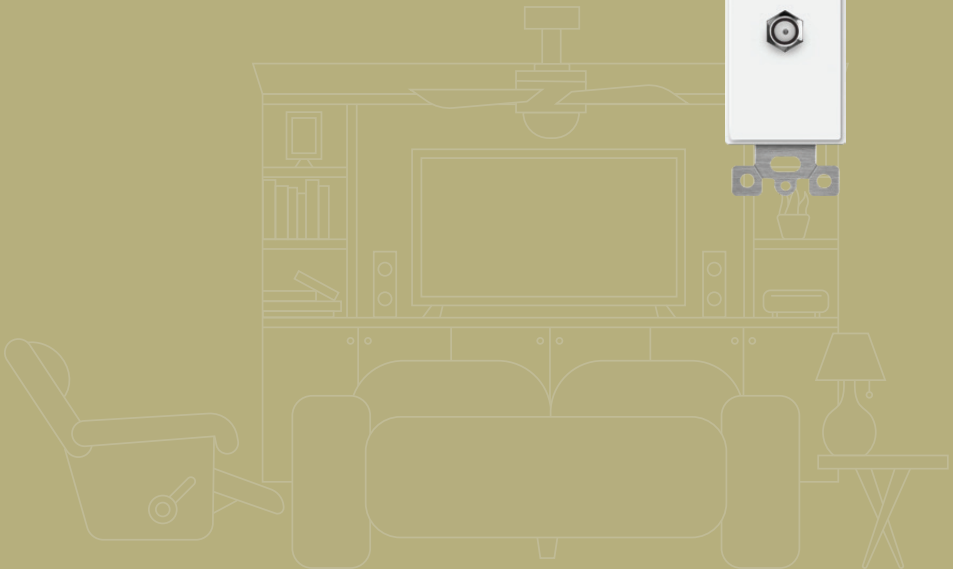

## Audio/Video Connectors

### Application:

Enerlites Audio Video Connectors allow custom creation of multimedia outlets and workstations while maintaining a decorative look.

### Features:

- Quick and secure snap-in design
- Use with multimedia plates and decorator frames
- 2-year warranty

### Testing & Code Compliance:



6102-W



6103-W

Audio/Video Connectors		
DESCRIPTION	CAT. NO.	COLOR
Gold F-Type Coupler Bulkhead, Female to Female 	6101	White Light Almond Ivory
Nickel F-Type Coupler Bulkhead, Female to Female 	6102	White Light Almond Ivory
Blank Insert 	6103	White Light Almond Ivory
Category 6 Jacks 	6104	White Ivory
Category 5e Jacks 	6105	White Light Almond
Phone Jacks 	6106	White Light Almond Ivory
HDMI Keystone 	6107	White Black
HDMI Keystone with Pigtail 	6108	Black
Banana Jacks 	6109	Black/Red
Cat6 Coupler 	6110	White Blue





## Decorator Adapters

### Application:

Enerlites Decorator Adapters provide a stylized look for that finishing touch.

### Features:

- Dimmer plastic shaft adapter permits the use of rotary dimmers or to pull through AV or telephone cable
- Blank plastic adapter covers blank holes in multi-device decorator installations
- High-impact resistant thermoplastic frame
- 2-year warranty

### Material Characteristics:

- Environmental: flammability UL94, V2 rating

### Testing & Code Compliance:



## Decorator Adapters



6061-W



6262-W

DESCRIPTION	CAT. NO.	COLOR
Dimmer Plastic Shaft Adapter 0.406" Dia. Hole	6061	White Ivory
<b>Blank Adapter</b>	<b>6001</b>	White Light Almond Ivory Black <b>Gray</b>
Toggle Blank Adapter	6002	White
1-Port Data Insert	6261	White
2-Port Data Insert	6262	White
3-Port Data insert	6263	White
4-Port Data Insert	6264	White
6-Port Data Insert	6266	White



## Multimedia Wall Plates

### Features:

- High-impact resistant thermoplastic plate
- Accepts voice/data and audio/video modules to support multimedia applications
- Available in 1, 2, 3, 4, or 6 port versions
- 2-year warranty

### Material Characteristics:

- Environmental: flammability UL94, V2 rating





### Testing & Code Compliance:



8872-W



8874-W

Multimedia Wall Plates		
DESCRIPTION	CAT. NO.	COLOR
1-Gang, 1-Port Plate 	8871	White Ivory
1-Gang, 2-Port Plate 	8872	White Ivory
1-Gang, 3-Port Plate 	8873	White Ivory
1-Gang, 4-Port Plate 	8874	White Ivory
1-Gang, 6-Port Plate 	8876	White Ivory



## Recessed Cable Plates

### Features:



- Large opening for easy access
- No sharp edges
- Durable construction
- Made for hiding low voltage cables inside walls
- Great for installations behind TVs and entertainment centers
- 2-year warranty

### Material Characteristics:

- Environmental: flammability UL94, V2 rating

### Testing & Code Compliance:



Split Style TV Plate with Flexible AV/HDMI Cable Pass-Through			
DESCRIPTION		CAT. NO.	COLOR
1-Gang Multimedia Bristled Pass-Through Decorative Adapter with Decorative Wall Plate		8891	White
1-Gang Multimedia Rubber Pass-Through Decorative Adapter with Decorative Wall Plate		8901	White

Low Voltage Pull Center			
DESCRIPTION		CAT. NO.	COLOR
1-Gang Recessed Multimedia Pull-Through Cover		8881	White
2-Gang Recessed Multimedia Pull-Through Cover		8882	White

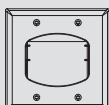

8891-W



8881-W

## Molded-In Voice and Audio/Video

### Application:

Enerlites decorator module wall jacks offer voice and audio/video devices to fit within a decorator wall plate. Create a look to match your voice/data, switch, and receptacle devices.

### Features:

- High-impact resistant thermoplastic frame
- 2-year warranty

### Material Characteristics:

- Environmental: flammability UL94, V2 rating

### Testing & Code Compliance:



## Molded-In Voice and Audio/Video

DESCRIPTION		CAT. NO.	COLOR
One RJ11 Jack, 6-Position, 6-Conductor		6501	White Light Almond Ivory
Duplex RJ11 Jacks, 6-Position, 6-Conductor		6503	White Light Almond Ivory
One F-Type Connector Wall Jack Female to Female		6505	White Light Almond Ivory
Duplex F-Type Connectors Wall Jacks Female to Female		6506	White Ivory
Combination Wall Jacks One RJ11 Jack, 6-Position, 6-Conductor, One F-Type Connector Wall Jack Female to Female		6507	White Light Almond Ivory



## Telephone Wall Jacks

### Application:

Enerlites telephone jacks with wall plates provide an economical alternative to wall phone outlet placement.

### Features:





- High-impact resistant thermoplastic plate
- Meets FCC part 68
- 2-year warranty

### Material Characteristics:

- Environmental: flammability UL94, V2 rating

### Testing & Code Compliance:



Telephone Wall Jacks		DESCRIPTION	CAT. NO.	COLOR
	6611-W	1-Gang Opening Modular Telephone Jack, One RJ11 Jack, 6-Position, 4-Conductor	6611	White Ivory
	6631	1-Gang, One RJ11 Jack, 6-Position, 6-Conductor	6631	White Ivory
	6651-W	1-Gang Two Modular Telephone Jacks, Duplex RJ11 Jacks, 6-Position, 4-Conductor	6651	White Ivory
	6671	1-Gang, Duplex RJ11 Jacks, 6-Position, 6-Conductor	6671	White Ivory

## Telephone and CATV Jacks

### Application:

Enerlites telephone and CATV jacks with wall plates offer an economical alternative to basic performance needs.

### Features:

- High-impact resistant thermoplastic frame
- Combination jack and coax minimize ganging requirements
- Meets FCC part 68
- 2-year warranty

### Material Characteristics:

- Environmental: flammability UL94, V2 rating

### Testing & Code Compliance:



6621-W



6641-W

## Telephone and CATV Jacks

DESCRIPTION	CAT. NO.	COLOR
1-Gang, One F-Type Connector Wall Jack Female to Female	6601	White Ivory
1-Gang, Duplex F-Type Connectors Wall Jack Female to Female	6621	White Ivory
1-Gang, One F-Type Connector Wall Jack Female to Female, One RJ11 Jack 6-Position, 4-Conductor	6641	White Ivory
1-Gang, One F-Type Connector Wall Jack Female to Female, One RJ11 Jack 6-Position, 6-Conductor	6661	White Ivory
1-Gang Phone/Cable 0.406" Dia. Hole	8661	White Ivory
1-Gang Phone/Cable 0.625" Dia. Hole	8861	White Ivory

- Screwless Wall Plates L3 - L6
- Plastic Wall Plates L7 - L13
- Stainless Steel Wall Plates L14 - L18
- Weatherproof Covers & Boxes L19 - L20

The Enerlites line of wall plates addresses a wide range of residential, commercial, and industrial applications. Our wall plates are made of metal and polycarbonate materials.

# Wall Plates & Covers



E  
L1

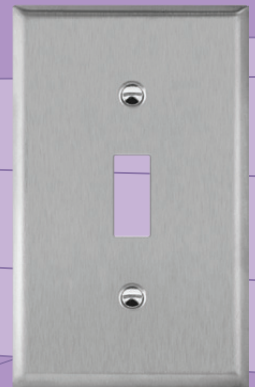



Besides the standard design, we also offer modern screwless wall plates, and weatherproof covers and enclosures.

Wall plates are available in a variety of configurations, colors, and finishes, as well as multi-gang combinations. In addition to the standard size, select wall plates are available in mid-size and oversized dimensions to cover varying amounts of wall space around the outlet.

Weatherproof enclosures cover receptacles and are installed outdoors and in other moisture-prone locations. The large, protective enclosures quick-fit around standard decorator switches and outlet receptacles to form a reliable waterproof seal and feature an easy-to-use flipping mechanism allowing for easy device access. Enerlites wall plates and covers are designed and built for heavy-duty, long-lasting applications.

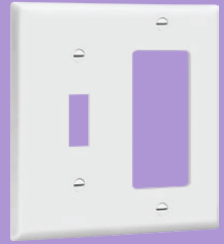
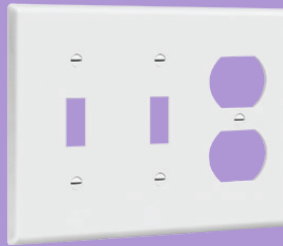
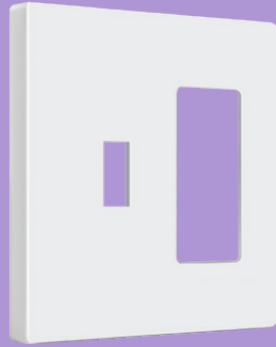



## Screwless Wall Plates

### Features:









- Made of thermoplastic material
- Screwless snap-in design for easy placement
- Decorator-compatible two piece kit allows easy retrofit to any decorator installation
- Durable to high impacts and resilient to bending and twisting during installations
- Smooth finish without recessed lines for easy cleaning and to maintain attractive appearance
- Captive screw features holds mounting screws in place for quick and easy installation
- Various colors available
- 2-year warranty

### Material Characteristics:

- Environmental: flammability UL94, V2 rating

### Testing & Code Compliance:

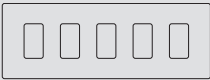

Screwless Decorator/GFCI Wall Plates			
DESCRIPTION	STANDARD SIZE	MID-SIZE	COLOR
 SI8831-W  1-Gang Decorator/GFCI	SI8831	SI8831M	White Light Almond Ivory Black Gray
 SI8832-W  2-Gang Decorator/GFCI	SI8832	SI8832M	White Light Almond Ivory Black Gray
 3-Gang Decorator/GFCI	SI8833	SI8833M	White Light Almond Ivory Black Gray
 4-Gang Decorator/GFCI	SI8834	SI8834M	White Light Almond Ivory Black Gray
 5-Gang Decorator/GFCI	SI8835	- - - - -	White Light Almond Ivory Black Gray
 6-Gang Decorator/GFCI	SI8836	- - - -	White Light Almond Ivory Black Gray

## Screwless Wall Plates

### Features:

- Made of thermoplastic material
- Screwless snap-in design for easy placement
- Decorator-compatible two piece kit allows easy retrofit to any decorator installation
- Durable to high impacts and resilient to bending and twisting during installations
- Smooth finish without recessed lines for easy cleaning and to maintain attractive appearance
- Captive screw features holds mounting screws in place for quick and easy installation
- Various colors available
- 2-year warranty

### Material Characteristics:

- Environmental: flammability UL94, V2 rating



### Testing & Code Compliance:



### Screwless Duplex Wall Plates







SI8821-W

DESCRIPTION	STANDARD SIZE	COLOR
<b>1-Gang Duplex</b> 	SI8821	White Light Almond Ivory Black Gray
<b>2-Gang Duplex</b> 	SI8822	White Light Almond Ivory Black Gray

### Screwless Toggle Wall Plates



SI8811-W

DESCRIPTION	STANDARD SIZE	COLOR
<b>1-Gang Toggle</b> 	SI8811	White Light Almond Ivory Black Gray
<b>2-Gang Toggle</b> 	SI8812	White Light Almond Ivory Black Gray
<b>3-Gang Toggle</b> 	SI8813	White Light Almond Ivory Black Gray
<b>4-Gang Toggle</b> 	SI8814	White Light Almond Ivory Black Gray

## Screwless Wall Plates

### Features:

- Made of thermoplastic material
- Screwless snap-in design for easy placement
- Decorator-compatible two piece kit allows easy retrofit to any decorator installation
- Durable to high impacts and resilient to bending and twisting during installations
- Smooth finish without recessed lines for easy cleaning and to maintain attractive appearance
- Captive screw features holds mounting screws in place for quick and easy installation
- Various colors available
- 2-year warranty

### Material Characteristics:

- Environmental: flammability UL94, V2 rating



### Testing & Code Compliance:



## Screwless Blank Wall Plates



SI8801-W

DESCRIPTION	STANDARD SIZE	COLOR
<b>1-Gang Blank</b> 	<b>SI8801</b>	White Light Almond Ivory Black Gray
<b>2-Gang Blank</b> 	<b>SI8802</b>	White Light Almond Ivory Black Gray

## Combination Screwless Wall Plate

DESCRIPTION	STANDARD SIZE	COLOR
<b>2-Gang Toggle and Decorator/GFCI</b> 	<b>SI881131</b>	White Light Almond Ivory Black Gray

## Screwless Wall Plates

### Features:

- Made of thermoplastic material
- Screwless snap-in design for easy placement
- Decorator-compatible two piece kit allows easy retrofit to any decorator installation
- Durable to high impacts and resilient to bending and twisting during installations
- Smooth finish without recessed lines for easy cleaning and to maintain attractive appearance
- Captive screw feature holds mounting screws in place for quick and easy installation
- Various colors available
- 2-year warranty

### Material Characteristics:

- Environmental: flammability UL94, V2 rating

### Testing & Code Compliance:



## Screwless Data-Com Wall Plates



SI8871-W



SI8874-W

DESCRIPTION	STANDARD SIZE	COLOR
1-Gang 1-Port 	SI8871	White
1-Gang 2-Port 	SI8872	White
1-Gang 3-Port 	SI8873	White
1-Gang 4-Port 	SI8874	White
1-Gang 6-Port 	SI8876	White



## Plastic Wall Plates

### Features:



- Made of thermoplastic material
- Durable to high impacts and resilient to bending and twisting during installations
- Smooth finish without recessed lines for easy cleaning and to maintain attractive appearance
- Various colors available
- 2-year warranty

### Material Characteristics:

- Environmental: flammability UL94, V2 rating

### Testing & Code Compliance:



Plastic Blank Wall Plates					
	DESCRIPTION	STANDARD SIZE	MID-SIZE	OVER-SIZE	COLOR
 <p>8801-W</p>  <p>8802-W</p>	<b>1-Gang Blank</b> 	8801	8801M	8801O	White Light Almond Ivory Black Gray
	2-Gang Blank 	8802	8802M	8802O	White Light Almond Ivory Black Gray
	3-Gang Blank 	8803	-	-	White Light Almond Ivory Black Gray
	4-Gang Blank 	8804	-	-	White Light Almond Ivory Black Gray

## Plastic Wall Plates

### Features:

- Made of thermoplastic material
- Durable to high impacts and resilient to bending and twisting during installations
- Smooth finish without recessed lines for easy cleaning and to maintain attractive appearance
- Various colors available
- 2-year warranty

### Material Characteristics:

- Environmental: flammability UL94, V2 rating

### Testing & Code Compliance:



## Plastic Toggle Wall Plates

DESCRIPTION	STANDARD SIZE	MID-SIZE	OVER-SIZE	COLOR
<b>1-Gang Toggle</b> 	8811	8811M	8811O	<b>White</b> Light Almond <b>Ivory</b> Black Gray Red Emergency Red
<b>2-Gang Toggle</b> 	8812	8812M	8812O	<b>White</b> Light Almond <b>Ivory</b> Black Gray Red
<b>3-Gang Toggle</b> 	8813	8813M	-	White Light Almond Ivory Black Gray
<b>4-Gang Toggle</b> 	8814	8814M	-	White Light Almond Ivory Black Gray
<b>5-Gang Toggle</b> 	8815	8815M	-	White Light Almond Ivory Black Gray
<b>6-Gang Toggle</b> 	8816	8816M	-	White Light Almond Ivory Black Gray



8811-W



8812-W

## Plastic Wall Plates

### Features:

- Made of thermoplastic material
- Durable to high impacts and resilient to bending and twisting during installations
- Smooth finish without recessed lines for easy cleaning and to maintain attractive appearance
- Various colors available
- 2-year warranty

### Material Characteristics:

- Environmental: flammability UL94, V2 rating

### Testing & Code Compliance:



## Plastic Duplex Wall Plates



8821-W



8822-W

DESCRIPTION	STANDARD SIZE	MID-SIZE	OVER-SIZE	COLOR
<b>1-Gang Duplex</b> 	8821	8821M	8821O	White Light Almond Ivory Black Gray Red Emergency Red
2-Gang Duplex 	8822	8822M	8822O	White Light Almond Ivory Black Gray Red Emergency Red
3-Gang Duplex 	8823	8823M	-	White Light Almond Ivory Black Gray
4-Gang Duplex 	8824	8824M	-	White Light Almond Ivory Black Gray

## Plastic Wall Plates

### Features:

- Made of thermoplastic material
- Durable to high impacts and resilient to bending and twisting during installations
- Smooth finish without recessed lines for easy cleaning and to maintain attractive appearance
- Various colors available
- 2-year warranty

### Material Characteristics:

- Environmental: flammability UL94, V2 rating

### Testing & Code Compliance:

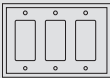
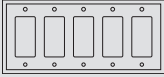
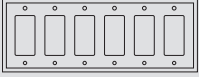

## Plastic Decorator/GFCI Wall Plates

DESCRIPTION	STANDARD SIZE	MID-SIZE	OVER-SIZE	COLOR
 <p>1-Gang Decorator/GFCI</p>	8831	8831M	8831O	White Light Almond Ivory Black Gray Red Emergency Red
 <p>2-Gang Decorator/GFCI</p>	8832	8832M	8832O	White Light Almond Ivory Black Gray Red Emergency Red
 <p>3-Gang Decorator/GFCI</p>	8833	8833M	-	White Light Almond Ivory Black Gray
 <p>4-Gang Decorator/GFCI</p>	8834	8834M	-	White Light Almond Ivory Black Gray
 <p>5-Gang Decorator/GFCI</p>	8835	8835M	-	White Light Almond Ivory Black Gray
 <p>6-Gang Decorator/GFCI</p>	8836	8836M	-	White Light Almond Ivory Black Gray



8831-W



8832-W



## Plastic Wall Plates

### Features:







- Made of thermoplastic material
- Durable to high impacts and resilient to bending and twisting during installations
- Smooth finish without recessed lines for easy cleaning and to maintain attractive appearance
- Various colors available
- 2-year warranty

### Material Characteristics:

- Environmental: flammability UL94, V2 rating

### Testing & Code Compliance:



Plastic NEMA Wall Plates		
DESCRIPTION	STANDARD SIZE	COLOR
 <p>8851-W</p>  <p>8852-W</p> <p>1-Gang Single Receptacle with 1.406" Dia. Hole</p> 	8851	White Light Almond Ivory
<p>2-Gang Single Receptacle with 1.406" Dia Holes</p> 	8852	White Ivory
<p>1-Gang Locking Outlet, 1.6" Dia Hole</p> 	8961	White
<p>1-Gang Power Outlet, 2.125" Dia Hole</p> 	8971	White
<p>2-Gang Power Outlet, 2.125" Dia Hole</p> 	8972	White

## Plastic Wall Plates

### Features:

- Made of thermoplastic material
- Durable to high impacts and resilient to bending and twisting during installations
- Smooth finish without recessed lines for easy cleaning and to maintain attractive appearance
- Various colors available
- 2-year warranty

### Material Characteristics:

- Environmental: flammability UL94, V2 rating

### Testing & Code Compliance:



Plastic Combination Two-Gang Wall Plates				
	DESCRIPTION	STANDARD SIZE	MID-SIZE	COLOR
	2-Gang Blank and Toggle 	880111	- -	White Ivory
881131-W	2-Gang Blank and Duplex 	880121	- -	White Ivory
	2-Gang Blank and Decorator/GFCI 	880131	- -	White Ivory
882131-W	2-Gang Toggle and Duplex 	881121	881121M	White Ivory
	2-Gange Toggle and Decorator/GFCI 	881131	881131M	White Ivory
	2-Gang Duplex and Decorator/GFCI 	882131	882131M	White Ivory

## Plastic Wall Plates

### Features:





- Made of thermoplastic material
- Durable to high impacts and resilient to bending and twisting during installations
- Smooth finish without recessed lines for easy cleaning and to maintain attractive appearance
- Various colors available
- 2-year warranty

### Material Characteristics:

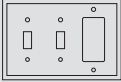

- Environmental: flammability UL94, V2 rating

### Testing & Code Compliance:

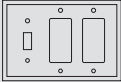

Plastic Combination Three-Gang Wall Plates		
DESCRIPTION	STANDARD SIZE	COLOR
 <p>881221-W</p> <p>3-Gang 2 Toggles and Duplex</p> 	881221	White Ivory
 <p>881231-W</p> <p>3-Gang 2 Toggles and Decorator/GFCI</p> 	881231	White Ivory Black
 <p>881132-W</p> <p>3-Gang Toggle and 2 Decorator/GFCI</p> 	881132	White Ivory Black Gray

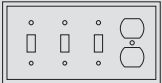
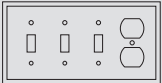
## Plastic Combination Four-Gang Wall Plates

DESCRIPTION	STANDARD SIZE	COLOR
 <p>881321-W</p> <p>4-Gang 3 Toggles and Duplex</p> 	881321	White Ivory
 <p>881331-W</p> <p>4-Gang 3 Toggles and Decorator/GFCI</p> 	881331	White Ivory

## Stainless Steel Wall Plates

### Features:



- Made of 430 stainless steel
- Provides extended life in extreme and corrosive environments
- Smooth finish without recessed lines for easy cleaning and to maintain attractive appearance
- 2-year warranty

### Testing & Code Compliance:



7701





### Stainless Steel Blank Wall Plates

DESCRIPTION	STANDARD SIZE	MID-SIZE	OVER-SIZE	MATERIAL
<b>1-Gang Blank</b> 	7701	7701M	7701O	Stainless Steel
<b>2-Gang Blank</b> 	7702	-	-	Stainless Steel
<b>3-Gang Blank</b> 	7703	-	-	Stainless Steel
<b>4-Gang Blank</b> 	7704	-	-	Stainless Steel



7711

### Stainless Steel Toggle Wall Plates

DESCRIPTION	STANDARD SIZE	MID-SIZE	OVER-SIZE	MATERIAL
<b>1-Gang Toggle</b> 	7711	7711M 7711M-E*	7711O	Stainless Steel
<b>2-Gang Toggle</b> 	7712	7712M 7712M-E*	-	Stainless Steel
<b>3-Gang Toggle</b> 	7713	7713M	-	Stainless Steel
<b>4-Gang Toggle</b> 	7714	7714M	-	Stainless Steel

\* Emergency

## Stainless Steel Wall Plates

### Features:



- Made of 430 stainless steel
- Provides extended life in extreme and corrosive environments
- Smooth finish without recessed lines for easy cleaning and to maintain attractive appearance
- 2-year warranty

### Testing & Code Compliance:



7721

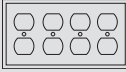

### Stainless Steel Duplex Wall Plates

DESCRIPTION	STANDARD SIZE	MID-SIZE	OVER-SIZE	MATERIAL
<b>1-Gang Duplex</b> 	<b>7721</b>	7721M 7721M-E*	7721O	Stainless Steel
<b>2-Gang Duplex</b> 	7722	7722M 7722M-E*	-	Stainless Steel
<b>3-Gang Duplex</b> 	7723	-	-	Stainless Steel
<b>4-Gang Duplex</b> 	7724	-	-	Stainless Steel



7731

### Stainless Steel Decorator/GFCI Wall Plates

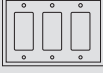
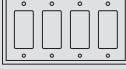
DESCRIPTION	STANDARD SIZE	MID-SIZE	OVER-SIZE	MATERIAL
<b>1-Gang Decorator/GFCI</b> 	<b>7731</b>	7731M 7731M-E*	7731O	Stainless Steel
<b>2-Gang Decorator/GFCI</b> 	7732	7732M 7732M-E*	-	Stainless Steel
<b>3-Gang Decorator/GFCI</b> 	7733	7733M	-	Stainless Steel
<b>4-Gang Decorator/GFCI</b> 	7734	7734M	-	Stainless Steel

\* Emergency

## Stainless Steel Wall Plates

### Features:

- Made of 430 stainless steel
- Provides extended life in extreme and corrosive environments
- Smooth finish without recessed lines for easy cleaning and to maintain attractive appearance
- 2-year warranty

### Testing & Code Compliance:



7741

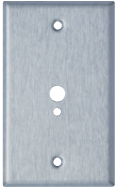

7781

### Stainless Steel Audio/Video Wall Plates

DESCRIPTION	STANDARD SIZE	MATERIAL
1-Gang Phone/Cable, 0.406" Dia. Hole 	7741	Stainless Steel
2-Gang Phone/Cable, 0.406" Dia. Holes 	7742	Stainless Steel
1-Gang Phone/Cable, 0.625" Dia. Hole 	7761	Stainless Steel
2-Gang Phone/Cable, 0.625" Dia. Holes 	7762	Stainless Steel
1-Gang Phone/Cable, 0.374" & 0.177" Dia. Hole 	7781	Stainless Steel
1-Gang Phone/Cable, 0.4375" Dia. Hole 	7841	Stainless Steel
1-Gang Phone, 1.405" Dia. Hole 	7941	Stainless Steel

## Stainless Steel Wall Plates



### Features:

- Made of 430 stainless steel
- Provides extended life in extreme and corrosive environments
- Smooth finish without recessed lines for easy cleaning and to maintain attractive appearance
- 2-year warranty

### Testing & Code Compliance:



### Stainless Steel Single Receptacle Wall Plates

DESCRIPTION	STANDARD SIZE	MID-SIZE	OVER-SIZE	MATERIAL
1-Gang Single Receptacle, 1.406" Dia. Hole 	7751	-	77510	Stainless Steel
2-Gang Single Receptacle, 1.406" Dia. Holes 	7752	-	-	Stainless Steel
1.6" Diameter Locking Device Receptacle 	7861	-	-	Stainless Steel



7861



7771

### Stainless Steel Power Outlet Receptacle One-Gang

DESCRIPTION	STANDARD SIZE	MID-SIZE	OVER-SIZE	MATERIAL
1-Gang Power Outlet, 2.125" Dia. Hole 	7771	-	-	Stainless Steel

### Stainless Steel Power Outlet Receptacle Two-Gang

DESCRIPTION	STANDARD SIZE	MID-SIZE	OVER-SIZE	MATERIAL
2-Gang Power Outlet, 2.125" Dia. Hole 	7772	-	-	Stainless Steel
2-Gang Power Outlet, 2.125" Dia. Hole Midway 	7792	-	-	Stainless Steel
2-Gang Power Outlet, 2.275" Dia. Hole Offset 	7892	-	-	Stainless Steel
2-Gang Power Outlet, 2.456" Dia. Hole 	7992	-	-	Stainless Steel



7772











## Stainless Steel Wall Plates

### Features:

- Made of 430 stainless steel
- Provides extended life in extreme and corrosive environments
- Smooth finish without recessed lines for easy cleaning and to maintain attractive appearance
- 2-year warranty

### Testing & Code Compliance:

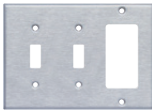

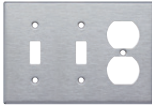
		Stainless Steel Combination Two-Gang Wall Plates				
		DESCRIPTION	STANDARD SIZE	MID-SIZE	OVER-SIZE	MATERIAL
 <p>771121</p>		2-Gang Blank and Toggle	770111	-	-	Stainless Steel
		2-Gang Blank and Duplex	770121	-	-	Stainless Steel
 <p>771131</p>		2-Gang Blank and Decorator/GFCI	770131	-	-	Stainless Steel
		2-Gang Toggle and Duplex	771121	771121M	771121O	Stainless Steel
		2-Gang Toggle and Decorator/GFCI	771131	771131M	-	Stainless Steel
		2-Gang Duplex Receptacle and Decorator/GFCI	772131	-	-	Stainless Steel
 <p>771231</p>		2-Gang Duplex and Single Receptacle 1.406" Dia. Hole	772151	-	-	Stainless Steel
	<h3>Stainless Steel Combination Three-Gang Wall Plates</h3>					
 <p>7712210</p>		3-Gang 2-Toggle and Decorator/GFCI	771231	-	-	Stainless Steel
		3-Gang 2-Toggle and Duplex	-	-	7712210	Stainless Steel





## In-Use Weatherproof Covers Extra Duty

### Features:

- Made of polycarbonate
- Quick fit installs in seconds
- Includes gasket and mounting hardware
- UV resistant, non-corrosive, non-conductive
- 2-year warranty

### Testing & Code Compliance:



### In-Use Weatherproof Covers Extra Duty



IUC1V-D



IUC2V-D

DESCRIPTION	CAT. NO.	MOUNTING	COLOR
Decorator: includes heavy duty watertight gasket and mounting screws	IUC1V-D	Vertical	Clear
Decorator: includes heavy duty watertight gasket and mounting screws	IUC1HV-D	Horizontal and/or Vertical	Clear
2 Decorator: includes heavy duty watertight gasket and mounting screws	IUC2V-D	Vertical	Clear

## Weatherproof Wall Plates/Outlet Boxes

### Features:

- Made of polycarbonate
- Quick fit installs in seconds
- Includes gasket and mounting hardware
- UV resistant, non-corrosive, non-conductive
- 2-year warranty

### Testing & Code Compliance:



Weatherproof Power Box		
DESCRIPTION	CAT. NO.	COLOR
<b>Weatherproof Outdoor Power Box, 50A 14-50R</b>	<b>66500M</b>	<b>Gray</b>
Weatherproof Outdoor Power Box, 30A TT-30R	63300M	Gray



66500M

Weatherproof Wall Plates		
DESCRIPTION	CAT. NO.	COLOR
Horizontal Duplex Weatherproof Wall Plate	8821-WPH	White Gray
Vertical Duplex Weatherproof Wall Plate	8821-WPV	White Gray
Vertical Decorator Weatherproof Wall Plate	8831-WPV	White Gray
Metallic 1-Gang Weatherproof Blank Cover	7701-WP	Gray
Metallic 2-Gang Weatherproof Blank Cover	7702-WP	Gray
Metallic 4" Round Weatherproof Blank Cover	7740-WP	Gray



8831-WPV-GY



Weatherproof Metal Electrical Boxes		
DESCRIPTION	CAT. NO.	COLOR
1/2 in. 1-Gang 3-Holes Weatherproof Outlet Box	EN1350	Gray
3/4 in. 1-Gang 3-Holes Weatherproof Outlet Box	EN1375	Gray
1/2 in. 2-Gang 3-Holes Weatherproof Outlet Box	EN2350	Gray
1/2 in. 2-Gang 5-Holes Weatherproof Outlet Box	EN2550	Gray
3/4 in. 2-Gang 3-Holes Weatherproof Outlet Box	EN2375	Gray
3/4 in. 2-Gang 5-Holes Weatherproof Outlet Box	EN2575	Gray
4 in. Round Weatherproof Outlet Box with 5 1/2 in. Holes	EN4550	Gray
4 in. Round Weatherproof Outlet Box with 5 3/4 in. Holes	EN4575	Gray



EN1350



EN2350

Z-Wave Smart Devices M3

Wi-Fi Smart Devices M4

**ENERLITES** home automation devices bring your home into the modern age with customizable settings and remote control.

The line includes wall switches, receptacles, and modules that let users program their devices, set timers and schedules, monitor energy use, and create scenes by grouping devices. Best of all, users can control all of these settings wirelessly. We offer Wi-Fi-controlled devices that require a secure 2.4GHz wireless connection and Z-Wave devices that instead require connection to a Z-Wave Hub.

Wi-Fi and Z-Wave devices can be controlled and managed from your mobile device with our user-friendly smartphone app.

# Home Automation

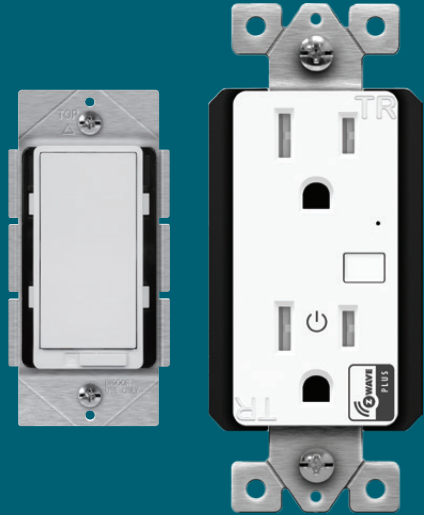

Z  
M1

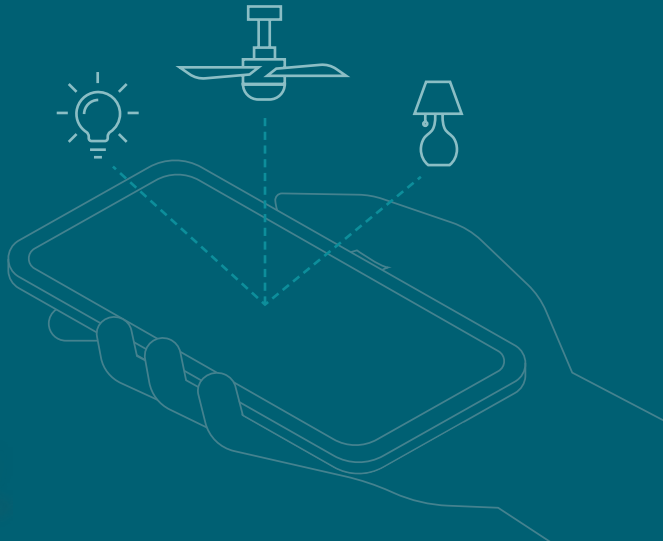



## Home Automation

One Touch Access to Easy Life

No matter where you are, using Enerlites Z-WAVE, only one touch can help you to control every room in your house.

"A single touch..."

Just add Z-Wave to your garage door, your home entry, and your home security system. When you arrive from work, push a button and all your Z-Wave devices will work in concert -- the garage door will open, your entryways will light up, your security system will recognize you, and your front door will unlock. How's that for remote control?

Once you're inside, your home can welcome you with just the mood you want. A single touch can have your favorite music playing for you on arrival, and the thermostat set to your preferred temperature. While you were away, it made sure the lawn sprinkler watered your lawn on schedule. If it rained, you could have bypassed the sprinkler while at work, from a PC or even a cell phone. When you're ready to call it a night, a single button can turn off your house lights, activate your security system, turn down the thermostat, lock the doors, turn on the bedroom humidifier, and set up the coffee pot to greet you with a fresh cup when you awake.

All with one button. All added easily and inexpensively to your home. All with no new wiring. And all according to your budget and timetables, to meet your needs and your lifestyle. Enerlites Z-Wave gives you simple, affordable, personalized control solutions.

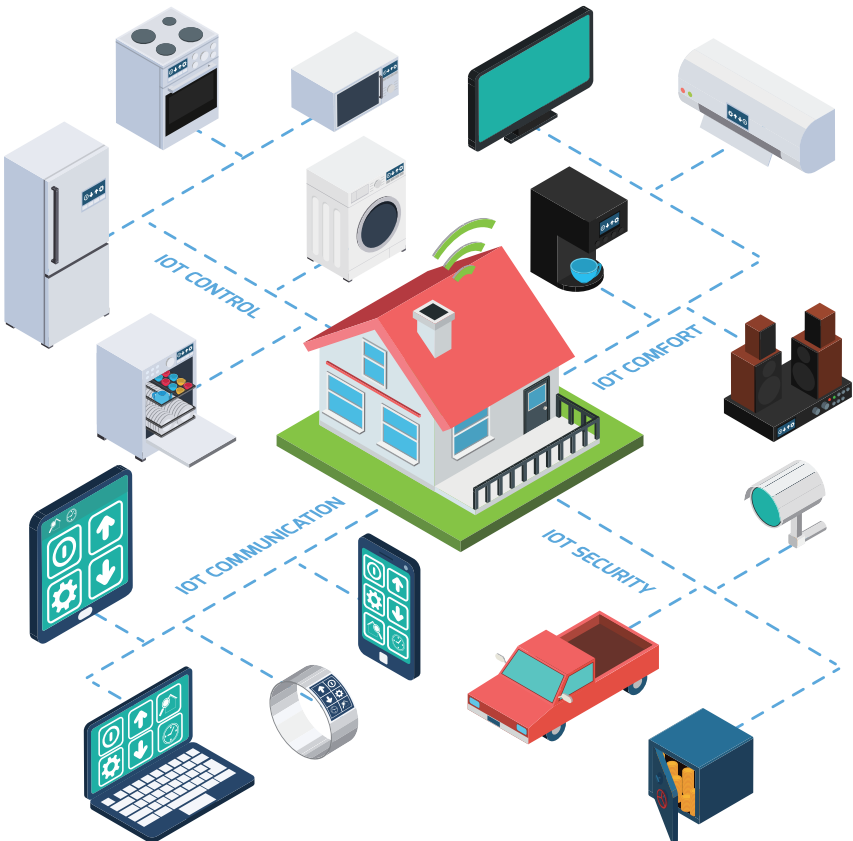



## Z-Wave Smart Devices

### Features:

- Alexa/Google Home voice control compatible - requires a Z-Wave Hub
- Increased energy efficiency with our Smart Meter Energy Monitoring technology
- Works with all certified Z-Wave devices (backwards compatible)
- Requires in-wall installation with hard-wired connections - neutral wire required
- Compatible with different loads
- Control many devices with a single controller locally, or via a computer/mobile phone remotely
- Wireless range: up to 100 feet (30 meters)
- 2-year warranty

### Testing & Code Compliance:



## Z-Wave Smart Devices



ZW15R-N



ZW-500DM-PLUS

DESCRIPTION	CAT. NO.	COLOR
Tamper-Resistant Duplex Receptacle, 120 VAC, 60 Hz 1000W Incandescent, 1/2 HP Motor, 1200 VA Ballast, 1800W (15A) Resistive 908.42 MHz	ZW15R-N	White
In-Wall Smart Meter Dimmer Switch 120 VAC, 60 Hz 500W Incandescent, 150W Dimmable LED and CFL 908.42 MHz	ZW500DM-PLUS	White
In-Wall 3-Way Auxiliary Switch 120 VAC, 60 Hz Works with ON/OFF Switch (ZW15S/ZW15SM) and Dimmer Switch (ZW500D/ZW500DM) in order to control one light/load from two locations	ZW3K	White
Smart Single Relay Switch Module 120-277 VAC, 50/60 Hz 10A 908.42 MHz	ZWN-RSM1-PLUS	Black
Smart Dual Relay Switch Module 120-277 VAC, 50/60 Hz 10A + 10A 908.42 MHz	ZWN-RSM2-PLUS	Black

## Wi-Fi Smart Devices

### Features:

- Works with ENERWAVE Wi-Fi App, no hub required
- Compatible with Amazon Alexa/Google Home for voice control
- Requires in-wall installation with hard wired connections - neutral wire required
- Compatible with different loads including LED
- Save energy by automating ON/OFF times or using timer
- 2-year warranty

### Testing & Code Compliance:



## Wi-Fi Smart Devices



WF15RM



WF2UM

DESCRIPTION	CAT. NO.	COLOR
In-Wall Wi-Fi 15A Duplex Receptacle, 120VAC, 60Hz 1000W Incandescent, 1/2 HP Motor, 1200 VA Ballast, 1800W (15A) Resistive 2.4 Ghz	WF15RM	White
In-Wall Wi-Fi 15A Tamper-Resistant Duplex Receptacle with Energy Monitoring and Dual USB Chargers Two USB Ports with Total Output 2.4A, 5 VDC Incandescent: 1000W Electronic Ballast: 800 VA Resistive: 15A Motor: 1/4 HP	WF2UM	White
Wi-Fi Smart In-Wall 15A ON/OFF Switch, 120 VAC, 60 Hz 1000W Incandescent, 1/2 HP Motor, 1200 VA Ballast, 1800W (15A) Resistive 2.4 Ghz	WF15S	White
Wi-Fi Smart In-Wall Dimmer Switch 120 VAC, 60 Hz 600W Incandescent, 150W Dimmable LED and CFL 2.4 Ghz	WF500D	White
3-Way Auxiliary Switch 120 VAC, 60 Hz Works with WF500D for Multi-Location ON/OFF and Dimming Control	WF3K	White
Smart Single Relay Switch Module 120-277 VAC, 50/60 Hz 10A 2.4 Ghz	WFRSM1	Black

Antimicrobial Switches	N2
Antimicrobial Wall Plates	N3

**ENERLITES'** antimicrobial treated devices consist of wall plates, toggle switches and decorator style switches. A silver ion coating provides antimicrobial properties. Silver ions work on a cellular level, preventing the growth and survival of unwanted microorganisms such as mold, mildew, fungus, and bacteria. This makes for an inherently disinfectant surface, as the frequently touched device will resist microbial growth.



# Antimicrobial Products



Made with silver ions



## Antimicrobial Switches

### Toggle Switch Features:

- 120/277V rating ideal for fluorescent lighting fixtures typical in commercial applications
- Side wired terminals; use 12 or 14 AWG copper wires only
- Large head double-drive combination screws (Standard, Phillips) for fast wiring
- Removable yoke tabs for ideal alignment
- Self-Grounding
- 2-year warranty

### Decorator Switch Features:

- Smooth, quiet paddle action
- Narrow body leaves more room for wires in the box
- High-impact resistant thermoplastic construction
- Removable yoke tabs for ideal alignment
- Captive mounting screws
- Push-in terminals for quick installation
- Easy-access green hex head ground screw
- Self-Grounding
- 2-year warranty

### Antimicrobial Features:

- Silver ion additive coating for antimicrobial properties
- Disinfectant surface resists microbial growth

### Material Characteristics:

- Environmental: flammability UL94, V2 rating
- Operating temperatures: from -104°F (without impact) to 167°F maximum continuous

### Testing & Code Compliance:



### Antimicrobial Toggle Switches Back and Side Wired

DESCRIPTION	CAT. NO.	COLOR
Single Pole 20A 120/277 VAC	81201A	White Black
3-Way 20A 120/277 VAC	83201A	White Black
4-Way 20A 120/277 VAC	84201A	White Black



81201A-W

### Antimicrobial Decorator Switches Push-In and Side Wired

DESCRIPTION	CAT. NO.	COLOR
Single Pole 15A 120/277 VAC	91150A	White Black
3-Way 15A 120/277 VAC	93150A	White Black



91150A-W



## Antimicrobial Wall Plates

### Stainless Steel Wall Plate Features:

- Made of 430 stainless steel
- Provides extended life in extreme and corrosive environments
- Smooth finish without recessed lines for easy cleaning and to maintain attractive appearance
- 2-year warranty

### Screwless Wall Plate Features:

- Made of thermoplastic material
- Screwless snap-in design for easy placement
- Decorator-compatible two piece kit allows easy retrofit to any decorator installation
- Durable to high impacts and resilient to bending and twisting during installations
- Smooth finish without recessed lines for easy cleaning and to maintain attractive appearance
- Captive screw features holds mounting screws in place for quick and easy installation
- 2-year warranty

### Antimicrobial Features:

- Silver ion additive coating for antimicrobial properties
- Disinfectant surface resists microbial growth

### Material Characteristics:

- Environmental: flammability UL94, V2 rating
- Operating temperatures: from -104°F (without impact) to 167°F maximum continuous

### Testing & Code Compliance:



7721MA-W

### Antimicrobial Stainless Steel Wall Plates

DESCRIPTION	STANDARD SIZE	MID-SIZE	MATERIAL
1-Gang Blank	-	7701MA	Stainless Steel
2-Gang Blank	-	7702MA	Stainless Steel
1-Gang Toggle	-	7711MA	Stainless Steel
2-Gang Toggle	-	7712MA	Stainless Steel
1-Gang Duplex	-	7721MA	Stainless Steel
2-Gang Duplex	-	7722MA	Stainless Steel
1-Gang Decorator/GFCI	-	7731MA	Stainless Steel
2-Gang Decorator/GFCI	-	7732MA	Stainless Steel



SI8831MA-W

### Antimicrobial Screwless Wall Plates

DESCRIPTION	STANDARD SIZE	MID-SIZE	COLOR
1-Gang Decorator/GFCI	SI8831A	SI8831MA	White Black
2-Gang Decorator/GFCI	SI8832A	SI8832MA	White Black
3-Gang Decorator/GFCI	SI8833A	SI8833MA	White Black
4-Gang Decorator/GFCI	SI8834A	SI8834MA	White Black
1-Gang Toggle	SI8811A	-	White Black
2-Gang Toggle	SI8812A	-	White Black
3-Gang Toggle	SI8813A	-	White Black
4-Gang Toggle	SI8814A	-	White Black

## INDEX

Model	Page	Model	Page	Model	Page
17000-F3-I	E4	6109-BKRD	K2	61501-TR3USB-CC-GY	A4
17000-F3-LA	E4	6110-BL	K2	61501-TR3USB-CC-W	A4
17000-F3-W	E4	6110-W	K2	61501-TR-BK	F7
17001-F3-I	E4	61150-A2C5-CU-W	A3	61501-TRGL-W	H3
17001-F3-LA	E4	61150-I	F4	61501-TR-GY	F7
17001-F3-W	E4	61150-TR2USB-CU-W	A3	61501-TR-I	F7
17003-I	E4	61150-TR3USB-CU-W	A3	61501-TR-LA	F7
17003-LA	E4	61150-TR-GY	F4	61501-TRRP-W	F3
17003-W	E4	61150-TR-I	F4	61501-TRSS-BK	F10
17006-W	E3	61150-TRRP-W	F3	61501-TRSS-W	F10
51300L-W	E3	61150-TR-W	F4	61501-TR-W	F7
51300-W	E3	61150-W	F4	61501-TWR-GY	F7
55300-W	E3	61160-I	F4	61501-TWR-W	F7
57302-W	E2	61160-W	F4	61501-W	F7
58300-3K-W	E2	61200-A2C5-CU-GY	A3	61510-O	F5
58300-W	E2	61200-A2C5-CU-W	A3	61510-TR-I	F5
59302-I	E3	61200-I	F4	61510-TR-W	F5
59302-LA	E3	61200-TR2USB-CU-W	A3	61540-BK	F4
59302-W	E3	61200-TR3USB-CU-W	A3	61540-I	F4
6001-BK	K3	61200-TR-GY	F4	61540-TR-BK	F4
6001-GY	K3	61200-TR-I	F4	61540-TR-I	F4
6001-I	K3	61200-TR-W	F4	61540-TR-LA	F4
6001-LA	K3	61200-W	F4	61540-TR-W	F4
6001-W	K3	61210-I	F4	61540-W	F4
6002-W	K3	61210-W	F4	61550-IG-O	F8
6061-I	K3	61500-IG-I	F8	61550-IG-W	F8
6061-W	K3	61500-IG-O	F8	61570-TR-I	F5
6101-I	K2	61500-IG-TR-I	F8	61570-TR-PLH-W	F4
6101-LA	K2	61500-IG-TR-O	F8	61570-TR-W	F5
6101-W	K2	61500-IG-TR-W	F8	61571-W	F5
6102-I	K2	61500-IG-W	F8	61580-GY	F3
6102-LA	K2	61501-1A1C5-W	A5	61580-I	F3
6102-W	K2	61501-1A1C-PD30-W	A6	61580-LA	F3
6103-I	K2	61501-1A1C-PD60-W	A6	61580-TR-BK	F3
6103-LA	K2	61501-2C3-W	A5	61580-TR-GY	F3
6103-W	K2	61501-2C5-W	A5	61580-TR-I	F3
6104-I	K2	61501-I	F7	61580-TR-LA	F3
6104-W	K2	61501-LA	F7	61580-TR-W	F3
6105-LA	K2	61501-TR2USB-1A1C-GY	A5	61580-TWR-GY	F3
6105-W	K2	61501-TR2USB-1A1C-W	A5	61580-TWR-W	F3
6106-I	K2	61501-TR2USB3-1A1C-B	A5	61580-W	F3
6106-LA	K2	61501-TR2USB3-1A1C-LA	A5	61610-O	F5
6106-W	K2	61501-TR2USB3-1A1C-W	A5	62000-4USB58-W	A4
6107-BK	K2	61501-TR2USB-CC-GY	A4	62000-IG-I	F8
6107-W	K2	61501-TR2USB-CC-W	A4	62000-IG-O	F8
6108-BK	K2	61501-TR2USB-S-W	A4	62000-IG-TR-I	F8

## INDEX

Model	Page	Model	Page	Model	Page
62000-IG-TR-W	F8	62080-I	F5	63200-TR-W	F8
62000-IG-W	F8	62080-TR-GY	F5	63200-W	F8
62001-1A1C5-W	A5	62080-TR-I	F5	63201-I	F8
62001-I	F7	62080-TR-PLH-W	F4	63201-W	F8
62001-LA	F7	62080-TR-W	F5	63300-BK	F9
62001-TR2USB-1A1C-GY	A5	62080-W	F5	63300M	L20
62001-TR2USB-1A1C-W	A5	62081-I	F5	6501-I	K6
62001-TR2USB3-1A1C-W	A5	62081-W	F5	6501-LA	K6
62001-TR2USB-CC-GY	A4	62150-TR-GY	H2	6501-W	K6
62001-TR2USB-CC-W	A4	62150-TR-W	H2	6503-I	K6
62001-TR3USB-CC-GY	A4	62580-TR-I	F3	6503-LA	K6
62001-TR3USB-CC-W	A4	62580-TR-LA	F3	6503-W	K6
62001-TR-LA	F7	62580-TR-W	F3	6505-I	K6
62001-TRSS-W	F10	6261-W	K3	6505-LA	K6
62001-TR-W	F7	6262-W	K3	6505-W	K6
62001-W	F7	6263-W	K3	6506-I	K6
62010-I	F5	6264-W	K3	6506-W	K6
62010-O	F5	6266-W	K3	6507-I	K6
62010-TR-I	F5	62755-GY	H2	6507-LA	K6
62010-TR-W	F5	62755-I	H2	6507-W	K6
62010-W	F5	62755-LA	H2	65300-BK	F9
62020-GY	F5	62755-W	H2	65351-BK	F9
62020-O	F5	62834-BK	H2	65352-BK	F9
62020-R	F5	62834-GY	H2	65500-BK	F9
62020-W	F5	62834-I	H2	6601-I	K8
62021-R	F5	62834-LA	H2	6601-W	K8
62021-W	F5	62834-W	H2	6611-I	K7
62040-BK	F4	62835-BK	H2	6611-W	K7
62040-I	F4	62835-GY	H2	66200-BK	I5
62040-TR-BK	F4	62835-I	H2	66201-BK	I5
62040-TR-GY	F4	62835-LA	H2	66203-W	I5
62040-TR-I	F4	62835-W	H2	66204-W	I5
62040-TR-LA	F4	63150-I	F8	66205-BK	I5
62040-TR-W	F4	63150-TR-GY	F8	66210-BK	I5
62040-TWR-GY	F4	63150-TR-I	F8	66211-BK	I5
62040-TWR-I	F4	63150-TR-PLH-GY	F7	66212-Y	I5
62040-TWR-W	F4	63150-TR-PLH-W	F7	66213-W	I5
62040-W	F4	63150-TR-W	F8	66214-W	I5
62050-IG-I	F8	63150-W	F8	66215-BK	I5
62050-IG-O	F8	63151-I	F8	6621-I	K8
62050-IG-W	F8	63151-W	F8	6621-W	K8
62060-TR-I	F7	63200-I	F8	66220-BK	I5
62060-TR-W	F7	63200-TR-GY	F8	66221-BK	I5
62060-TWR-GY	F7	63200-TR-I	F8	66223-W	I5
62060-TWR-W	F7	63200-TR-PLH-GY	F7	66224-W	I5
62060-W	F7	63200-TR-PLH-W	F7	66230-BK	I5

## INDEX

Model	Page	Model	Page	Model	Page
66231-BK	I5	66500-W	F9	7711	L14
66233-W	I5	66510-BK	I3	771121	L18
66234-W	I5	66511-BK	I3	771121M	L18
66300-BK	F9	66512-BK	I3	7711210	L18
66300-W	F9	6651-I	K7	771131	L18
6631-I	K7	6651-W	K7	771131M	L18
6631-W	K7	66600-BK	I3	7711M	L14
66351-BK	F9	66601-BK	I3	7711MA	N3
66352-BK	F9	66602-BK	I3	7711M-E	L14
66400-BK	I3	6661-I	K8	77110	L14
66401-BK	I3	6661-W	K8	7712	L14
66402-BK	I3	6671-I	K7	7712210	L18
66403-W	I3	6671-W	K7	771231	L18
66404-W	I3	66800-BK	I4	7712M	L14
66410-BK	I3	66801-BK	I4	7712MA	N3
66411-BK	I3	66802-BK	I4	7712M-E	L14
66412-BK	I3	66803-W	I4	7713	L14
66413-W	I3	66804-W	I4	7713M	L14
66414-W	I3	66900-BK	I3	7714	L14
6641-I	K8	66901-BK	I3	7714M	L14
6641-W	K8	66902-BK	I3	7721	L15
66420-BK	I3	66903-W	I3	772131	L18
66421-BK	I3	66904-W	I3	772151	L18
66422-BK	I3	67300-BK	F9	7721M	L15
66423-W	I3	67351-BK	F9	7721MA	N3
66424-W	I3	67500-BK	F9	7721M-E	L15
66440-BK	I4	68150-W	F5	77210	L15
66450-BK	I4	68151-O	F5	7722	L15
66452-BK	I4	68151-W	F5	7722M	L15
66453-W	I4	68625-TR-GY	H2	7722MA	N3
66454-W	I4	68625-TR-W	H2	7722M-E	L15
66460-BK	I4	69354-BK	F9	7723	L15
66461-BK	I4	69554-BK	F9	7724	L15
66462-BK	I4	7701	L14	7731	L15
66463-W	I4	770111	L18	7731M	L15
66464-W	I4	770121	L18	7731MA	N3
66470-BK	I4	770131	L18	7731M-E	L15
66480-BK	I3	7701M	L14	77310	L15
66481-BK	I3	7701MA	N3	7732	L15
66482-BK	I3	77010	L14	7732M	L15
66490-BK	I4	7701-WP	L20	7732MA	N3
66492-BK	I4	7702	L14	7732M-E	L15
66493-W	I4	7702MA	N3	7733	L15
66494-W	I4	7702-WP	L20	7733M	L15
66500-BK	F9	7703	L14	7734	L15
66500M	L20	7704	L14	7734M	L15

## INDEX

Model	Page	Model	Page	Model	Page
7740-WP	L20	83201A-W	N2	88020-LA	L7
7741	L16	83201-GY	G3	88020-W	L7
7742	L16	83201-LA	G3	8802-W	L7
7751	L17	83201-W	G3	8803-BK	L7
77510	L17	84150-I	G2	8803-GY	L7
7752	L17	84150-W	G2	8803-I	L7
7761	L16	84201A-BK	N2	8803-LA	L7
7762	L16	84201A-W	N2	8803-W	L7
7771	L17	84201-GY	G3	8804-BK	L7
7772	L17	84201-LA	G3	8804-GY	L7
7781	L16	84201-W	G3	8804-I	L7
7792	L17	8661-I	K8	8804-LA	L7
7841	L16	8661-W	K8	8804-W	L7
7861	L17	880111-I	L12	881121-I	L12
7892	L17	880111-W	L12	881121M-I	L12
7941	L16	880121-I	L12	881121M-W	L12
7992	L17	880121-W	L12	881121-W	L12
81200-GY	G2	880131-I	L12	881131-I	L12
81200-I	G2	880131-W	L12	881131M-I	L12
81200-W	G2	8801-BK	L7	881131M-W	L12
81201A-BK	N2	8801-GY	L7	881131-W	L12
81201A-W	N2	8801-I	L7	881132-BK	L13
81201-GY	G3	8801-LA	L7	881132-GY	L13
81201-LA	G3	8801M-BK	L7	881132-I	L13
81201-W	G3	8801M-GY	L7	881132-W	L13
82150-GY	H2	8801M-I	L7	88115-GY	G2
82150L-I	H2	8801M-LA	L7	88115-I	G2
82150L-W	H2	8801M-W	L7	88115-LA	G2
82150-W	H2	88010-BK	L7	88115L-C	G2
82200-BK	G3	88010-GY	L7	88115L-W	G2
82200-I	G3	88010-I	L7	88115-W	G2
82200-PL-R	G3	88010-LA	L7	8811-BK	L8
82200-W	G3	88010-W	L7	8811-GY	L8
82300-BK	G3	8801-W	L7	8811-I	L8
82300-I	G3	8802-BK	L7	8811-LA	L8
82300-PL-R	G3	8802-GY	L7	8811M-BK	L8
82300-W	G3	8802-I	L7	8811M-ER	L8
83150-GY	G2	8802-LA	L7	8811M-GY	L8
83150-I	G2	8802M-BK	L7	8811M-I	L8
83150-LA	G2	8802M-GY	L7	8811M-LA	L8
83150L-C	G2	8802M-I	L7	8811M-R	L8
83150L-W	G2	8802M-LA	L7	8811M-W	L8
83150-W	G2	8802M-W	L7	88110-BK	L8
83200-I	G2	88020-BK	L7	88110-GY	L8
83200-W	G2	88020-GY	L7	88110-I	L8
83201A-BK	N2	88020-I	L7	88110-LA	L8

## INDEX

Model	Page	Model	Page	Model	Page
88110-W	L8	8814-W	L8	8822-BK	L9
8811-W	L8	8815-BK	L8	8822-GY	L9
881221-I	L13	8815-GY	L8	8822-I	L9
881221-W	L13	8815-I	L8	8822-LA	L9
881231-BK	L13	8815-LA	L8	8822M-BK	L9
881231-I	L13	8815M-BK	L8	8822M-ER	L9
881231-W	L13	8815M-GY	L8	8822M-GY	L9
8812-BK	L8	8815M-I	L8	8822M-I	L9
8812-GY	L8	8815M-LA	L8	8822M-LA	L9
8812-I	L8	8815M-W	L8	8822M-R	L9
8812-LA	L8	8815-W	L8	8822M-W	L9
8812M-BK	L8	8816-BK	L8	88220-BK	L9
8812M-GY	L8	8816-GY	L8	88220-GY	L9
8812M-I	L8	8816-I	L8	88220-I	L9
8812M-LA	L8	8816-LA	L8	88220-LA	L9
8812M-R	L8	8816M-BK	L8	88220-W	L9
8812M-W	L8	8816M-GY	L8	8822-W	L9
88120-BK	L8	8816M-I	L8	8823-BK	L9
88120-GY	L8	8816M-LA	L8	8823-GY	L9
88120-I	L8	8816M-W	L8	8823-I	L9
88120-LA	L8	8816-W	L8	8823-LA	L9
88120-W	L8	882131-I	L12	8823M-BK	L9
8812-W	L8	882131M-I	L12	8823M-GY	L9
881321-I	L13	882131M-W	L12	8823M-I	L9
881321-W	L13	882131-W	L12	8823M-LA	L9
881331-I	L13	8821-BK	L9	8823M-W	L9
881331-W	L13	8821-GY	L9	8823-W	L9
8813-BK	L8	8821-I	L9	8824-BK	L9
8813-GY	L8	8821-LA	L9	8824-GY	L9
8813-I	L8	8821M-BK	L9	8824-I	L9
8813-LA	L8	8821M-ER	L9	8824-LA	L9
8813M-BK	L8	8821M-GY	L9	8824M-BK	L9
8813M-GY	L8	8821M-I	L9	8824M-GY	L9
8813M-I	L8	8821M-LA	L9	8824M-I	L9
8813M-LA	L8	8821M-R	L9	8824M-LA	L9
8813M-W	L8	8821M-W	L9	8824M-W	L9
8813-W	L8	88210-BK	L9	8824-W	L9
8814-BK	L8	88210-GY	L9	8831-BK	L10
8814-GY	L8	88210-I	L9	8831-GY	L10
8814-I	L8	88210-LA	L9	8831-I	L10
8814-LA	L8	88210-W	L9	8831-LA	L10
8814M-BK	L8	8821-W	L9	8831M-BK	L10
8814M-GY	L8	8821-WPH-GY	L20	8831M-ER	L10
8814M-I	L8	8821-WPH-W	L20	8831M-GY	L10
8814M-LA	L8	8821-WPV-GY	L20	8831M-I	L10
8814M-W	L8	8821-WPV-W	L20	8831M-LA	L10

## INDEX

Model	Page	Model	Page	Model	Page
8831M-R	L10	8834-W	L10	91150A-BK	N2
8831M-W	L10	8835-BK	L10	91150A-W	N2
88310-BK	L10	8835-GY	L10	91150-BK	G4
88310-GY	L10	8835-I	L10	91150-GL-W	H3
88310-I	L10	8835-LA	L10	91150-GY	G4
88310-LA	L10	8835M-BK	L10	91150-I	G4
88310-W	L10	8835M-GY	L10	91150-LA	G4
8831-W	L10	8835M-I	L10	91150-W	G4
8831-WPV-GY	L20	8835M-LA	L10	91160-GY	G5
8831-WPV-W	L20	8835M-W	L10	91160-I	G5
8832-BK	L10	8835-W	L10	91160-LA	G5
8832-GY	L10	8836-BK	L10	91160-W	G5
8832-I	L10	8836-GY	L10	91200-BK	G5
8832-LA	L10	8836-I	L10	91200-GY	G5
8832M-BK	L10	8836-LA	L10	91200-I	G5
8832M-ER	L10	8836M-BK	L10	91200-LA	G5
8832M-GY	L10	8836M-GY	L10	91200-W	G5
8832M-I	L10	8836M-I	L10	91245-I	G5
8832M-LA	L10	8836M-LA	L10	91245-W	G5
8832M-R	L10	8836M-W	L10	93150A-BK	N2
8832M-W	L10	8836-W	L10	93150A-W	N2
88320-BK	L10	8851-I	L11	93150-BK	G4
88320-GY	L10	8851-LA	L11	93150-GL-W	H3
88320-I	L10	8851-W	L11	93150-GY	G4
88320-LA	L10	8852-I	L11	93150-I	G4
88320-W	L10	8852-W	L11	93150-LA	G4
8832-W	L10	8861-I	K8	93150-W	G4
8833-BK	L10	8861-W	K8	93160-GY	G5
8833-GY	L10	8871-I	K4	93160-I	G5
8833-I	L10	8871-W	K4	93160-LA	G5
8833-LA	L10	8872-I	K4	93160-W	G5
8833M-BK	L10	8872-W	K4	93200-BK	G5
8833M-GY	L10	8873-I	K4	93200-GY	G5
8833M-I	L10	8873-W	K4	93200-I	G5
8833M-LA	L10	8874-I	K4	93200-LA	G5
8833M-W	L10	8874-W	K4	93200-W	G5
8833-W	L10	8876-I	K4	94150-BK	G4
8834-BK	L10	8876-W	K4	94150-GY	G4
8834-GY	L10	8881-W	K5	94150-I	G4
8834-I	L10	8882-W	K5	94150-LA	G4
8834-LA	L10	8891-W	K5	94150-W	G4
8834M-BK	L10	8901-W	K5	961241-C	J3
8834M-GY	L10	8961-W	L11	961241-S	J3
8834M-I	L10	8971-W	L11	961243-C	J3
8834M-LA	L10	8972-W	L11	961243-C-GFCL	J3
8834M-W	L10	91000-GL-W	H3	961243-C-USB	J3

## INDEX

Model	Page	Model	Page	Model	Page
961243-S-GFCI	J3	DWHOS-L-BK	B14	HMOS-J-BK	B3
961243-S-USB	J3	DWHOS-L-LA	B14	HMOS-J-I	B3
961248-C-GFCI	J3	DWHOS-W	B14	HMOS-J-LA	B3
961248-C-USB	J3	DWHS-L-BK	B14	HMOS-J-W	B3
961248-S-GFCI	J3	DWHS-L-LA	B14	HMOS-LA	B3
961248-S-USB	J3	DWHS-W	B14	HMOS-W	B3
961501-C	J3	DWODS-010-W	B6	HMT01N-W	D2
961501-C-GFCI	J3	DWODS-120-W	B6	HMVS-BK	B3
961501-C-USB	J3	DWOS-1277-NL-W	B4	HMVS-I	B3
961501-S	J3	DWOS-1277-W	B4	HMVS-J-BK	B3
961501-S-GFCI	J3	DWOS-3J-W	B4	HMVS-J-I	B3
961501-S-USB	J3	DWOS-3R-W	B4	HMVS-J-LA	B3
962301-C	J4	DWOS-JD-W	B4	HMVS-J-W	B3
962301-C-D	J4	DWOS-J-W	B4	HMVS-LA	B3
962301-S	J4	DWTOS-L-BK	B15	HMVS-W	B3
962301-S-D	J4	DWTOS-L-LA	B15	IUC1HV-D	L19
975501-C	J4	DWTOS-W	B15	IUC1V-D	L19
975501-S	J4	DWTS-L-BK	B15	IUC2V-D	L19
975501-SS	J4	DWTS-L-LA	B15	LV-Cat5-W	B12
975502-C	J4	DWTS-W	B15	LVD-101-W	B12
975502-S	J4	EN1350	L20	LVD-102-W	B12
975503-C	J4	EN1375	L20	LVS-101-W	B12
975503-S	J4	EN2350	L20	LVS-102-W	B12
975506-C	J2	EN2375	L20	LVS-103-W	B12
975506-SS	J2	EN2550	L20	LVS-104-W	B12
975507-C	J2	EN2575	L20	MDC-50L-W	B11
975507-S	J2	EN4550	L20	MDC-50V-W	B8
975509-C	J5	EN4575	L20	MDW-L-W	B10
975509-S	J5	ENLC001	J5	MDW-V-W	B9
975510-C	J2	ENLC001AR	J5	MPC-50HD-W	B8
975510-C-D	J2	ENLC001LR	J5	MPC-50H-W	B8
975510-SS	J2	FB-02	J5	MPC-50L-W	B11
975510-SS-D	J2	HET01-H1-W	D2	MPC-50VD-W	B7
975516-SS	J4	HET01-I	D2	MPC-50V-W	B7
975517-C	J4	HET01-W	D2	MPC-52V10-W	B7
975517-S	J4	HET06-12-W	D4	MPC-52V-W	B7
975518-C	J5	HET06A-J-W	D3	MPC-A-W	B13
975518-S	J5	HET06A-R-I	D3	MPC-B-W	B13
975519-C	J4	HET06A-R-W	D3	MPC-C-W	B13
975519-S	J4	HET06-J-2H-W	D4	MPC-D-W	B13
975547-C	J2	HET06-J6-W	D3	MPL-010-W	B11
975547-SS	J2	HET06-J-W	D4	MPP-24-W	B13
975549-C	J2	HET06-R-I	D4	MPW-L-W	B10
975549-C-D	J2	HET06-R-W	D4	MPW-V-W	B9
975549-S	J2	HMOS-BK	B3	MWOS-W	B5
975549-S-D	J2	HMOS-I	B3	PL20R	C2



## INDEX

Model	Page	Model	Page	Model	Page
PLBPC	C2	SI8821-I	L4	SI8833M-I	L3
SI8801-BK	L5	SI8821-LA	L4	SI8833M-LA	L3
SI8801-GY	L5	SI8821-W	L4	SI8833M-W	L3
SI8801-I	L5	SI8822-BK	L4	SI8833-W	L3
SI8801-LA	L5	SI8822-GY	L4	SI8834A-BK	N3
SI8801-W	L5	SI8822-I	L4	SI8834A-W	N3
SI8802-BK	L5	SI8822-LA	L4	SI8834-BK	L3
SI8802-GY	L5	SI8822-W	L4	SI8834-GY	L3
SI8802-I	L5	SI8831A-BK	N3	SI8834-I	L3
SI8802-LA	L5	SI8831A-W	N3	SI8834-LA	L3
SI8802-W	L5	SI8831-BK	L3	SI8834MA-BK	N3
SI881131-BK	L5	SI8831-GY	L3	SI8834MA-W	N3
SI881131-GY	L5	SI8831-I	L3	SI8834M-BK	L3
SI881131-I	L5	SI8831-LA	L3	SI8834M-GY	L3
SI881131-LA	L5	SI8831MA-BK	N3	SI8834M-I	L3
SI881131-W	L5	SI8831MA-W	N3	SI8834M-LA	L3
SI8811A-BK	N3	SI8831M-BK	L3	SI8834M-W	L3
SI8811A-W	N3	SI8831M-GY	L3	SI8834-W	L3
SI8811-BK	L4	SI8831M-I	L3	SI8835-BK	L3
SI8811-GY	L4	SI8831M-LA	L3	SI8835-GY	L3
SI8811-I	L4	SI8831M-W	L3	SI8835-I	L3
SI8811-LA	L4	SI8831-W	L3	SI8835-LA	L3
SI8811-W	L4	SI8832A-BK	N3	SI8835-W	L3
SI8812A-BK	N3	SI8832A-W	N3	SI8836-BK	L3
SI8812A-W	N3	SI8832-BK	L3	SI8836-GY	L3
SI8812-BK	L4	SI8832-GY	L3	SI8836-I	L3
SI8812-GY	L4	SI8832-I	L3	SI8836-LA	L3
SI8812-I	L4	SI8832-LA	L3	SI8836-W	L3
SI8812-LA	L4	SI8832MA-BK	N3	SI8871-W	L6
SI8812-W	L4	SI8832MA-W	N3	SI8872-W	L6
SI8813A-BK	N3	SI8832M-BK	L3	SI8873-W	L6
SI8813A-W	N3	SI8832M-GY	L3	SI8874-W	L6
SI8813-BK	L4	SI8832M-I	L3	SI8876-W	L6
SI8813-GY	L4	SI8832M-LA	L3	USB15L3A2C-W	A3
SI8813-I	L4	SI8832M-W	L3	USB15L3AC-W	A3
SI8813-LA	L4	SI8832-W	L3	USB15L3-W	A3
SI8813-W	L4	SI8833A-BK	N3	USB20L3A2C-GY	A3
SI8814A-BK	N3	SI8833A-W	N3	USB20L3A2C-W	A3
SI8814A-W	N3	SI8833-BK	L3	USB20L3AC-GY	A3
SI8814-BK	L4	SI8833-GY	L3	USB20L3AC-W	A3
SI8814-GY	L4	SI8833-I	L3	USB20L3-W	A3
SI8814-I	L4	SI8833-LA	L3	WF15RM-W	M4
SI8814-LA	L4	SI8833MA-BK	N3	WF15S-W	M4
SI8814-W	L4	SI8833MA-W	N3	WF2UM-W	M4
SI8821-BK	L4	SI8833M-BK	L3	WF3K-W	M4
SI8821-GY	L4	SI8833M-GY	L3	WF500D-W	M4



**AVAILABLE COLORS**



Black



Blue



Gray

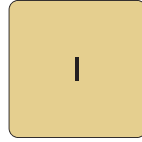

Ivory



Light Almond



Orange



Red



White



430 S/S

**CALL FOR COLOR AVAILABILITY**

# Enerlites®

Control  
Charge  
Connect

1 877 372 6447 toll free  
949 756 0536 tel  
949 756 0528 fax

[enerlites.com](http://enerlites.com)  
[sales@enerlites.com](mailto:sales@enerlites.com)

CODE 20230901  
All rights reserved, effective September 2023



Printed on recycled paper  
Environmentally friendly ink

